



IALA GUIDELINE

1094

DAYMARKS FOR AIDS TO NAVIGATION

Edition 2.0

June 2016



DOCUMENT REVISION

Revisions to this IALA Document are to be noted in the table prior to the issue of a revised document.

Date	Page / Section Revised	Requirement for Revision
June 2016	Full document	Inserted equation titles and Dictionary references, amended acronyms list.



CONTENTS

1. INTRODUCTION	8
2. SCOPE.....	8
3. DEFINITIONS	8
4. DAYMARK TOPMARK BASIC PRINCIPLES	8
4.1. Degrees of Perception and Range	9
4.2. Information Process.....	9
4.3. Visual Perception	10
5. THE DAYMARK – OBJECT.....	10
5.1. Profile.....	10
5.1.1. Flat daymark	11
5.1.2. Solid daymark with rotational symmetry	11
5.1.3. Crossed plates	12
5.1.4. Lattice construction	12
5.1.5. Comparison of 3D profile.....	13
5.2. Luminance of the object	13
5.3. Surface Colour	14
5.3.1. Specification	14
5.3.2. Aging of colour.....	15
5.3.3. Retroreflective sheeting	15
5.4. Size	16
5.5. Combination of colours	16
6. THE VIEWING CONDITIONS – MEDIA.....	17
6.1. Viewing Distance.....	17
6.2. Meteorological Visibility	18
6.3. Koschmieder's law	19
6.4. Background	20
6.4.1. Sky as the background	21
6.4.2. Sun behind a daymark	21
6.4.3. Water surface as background	21
6.4.4. Landscape as background	21
7. THE OBSERVER	22
7.1. Eye resolution and subtense angles	22
7.2. Non-uniform daymarks.....	22
7.3. Shape recognition	23
7.4. Required contrast	25
7.5. Colour recognition	25



CONTENTS

8. DESIGN OF DAYMARKS	25
8.1. Floating Aids	25
8.1.1. 3-D Profile.....	25
8.1.2. Colour	26
8.1.3. Size and shape of single coloured buoys	26
8.1.4. Size and Shape of Cardinal-buoys.....	26
8.1.5. Safe water and new-danger marks.....	28
8.1.6. Structural obstructions	28
8.1.7. Solar panels	29
8.1.8. Topmarks.....	30
8.2. Fixed aids	32
8.2.1. Traditional lighthouses	32
8.2.2. Additional tools for structures used as daymarks	34
8.2.3. White daymarks.....	35
8.2.4. Dayboard of leading lines	36
8.2.5. Marking of bridges.....	37
8.2.6. Design of signs	37
8.3. General Design Methodology	38
8.3.1. Input	39
8.3.2. Step 1.....	39
8.3.3. Step 2.....	39
8.3.4. Step 3.....	39
8.3.5. Step 4.....	39
8.3.6. Step 5.....	39
8.4. Limitations and Service factors.....	40
8.4.1. Supporting structure	40
8.4.2. Colour fading	40
8.4.3. Bird fouling	40
8.4.4. Environmental Considerations in Buoy design	40
8.5. Design Examples	40
8.5.1. EXAMPLE 1.....	40
8.5.2. EXAMPLE 2.....	41
8.5.3. EXAMPLE 3.....	42
8.5.4. EXAMPLE 4.....	43
8.5.5. EXAMPLE 5.....	44
9. ACRONYMS AND ABBREVIATIONS	45
10. REFERENCES	46
ANNEX A PHYSICAL MODEL OF KOSCHMIEDER'S LAW	47
ANNEX B STATISTICAL DISTRIBUTION OF SKY LUMINANCE	48
ANNEX C SIMPLE MODEL OF THE HUMAN EYE	49
ANNEX D BLAISE THEORY¹.....	51



CONTENTS

ANNEX E EXAMPLE CANADIAN DAYMARKS52

List of Tables

Table 1	<i>The three degrees of perception of daymarks.....</i>	9
Table 2	<i>Comparison of profiles.....</i>	13
Table 3	<i>Values for the luminance factor β and Numbers of colour collections.....</i>	15
Table 4	<i>Geographical Range in Nautical Miles (M).....</i>	18
Table 5	<i>Albedos for different surfaces [15].....</i>	21
Table 6	<i>Conventions on range and minimum viewing angle.....</i>	24
Table 7	<i>Typical values of daymark range.....</i>	24
Table 8	<i>Dayboard size and range.....</i>	37
Table 9	<i>Design distance for Canadian daybeacons.....</i>	52

List of Figures

Figure 1	<i>Information process.....</i>	10
Figure 2	<i>Perception of an extended object.....</i>	10
Figure 3	<i>Flat daymark and line between the vertical of the surface and the observer's direction.....</i>	11
Figure 4	<i>Projected (visible) shape of a flat daymark.....</i>	11
Figure 5	<i>Profiles with rotational symmetry.....</i>	11
Figure 6	<i>Profiles with crossed plates.....</i>	12
Figure 7	<i>Lattice construction derived from crossed plates.....</i>	12
Figure 8	<i>Lattice construction of a lateral buoy.....</i>	13
Figure 9	<i>CIE standard chromaticity diagram.....</i>	14
Figure 10	<i>Typical application for retroreflective sheets on a buoy.....</i>	16
Figure 11	<i>Lateral extension and range of a daymark.....</i>	16
Figure 12	<i>Single and multi coloured daymarks.....</i>	17
Figure 13	<i>Simplified illustration of light scattering in atmosphere.....</i>	19
Figure 14	<i>Sky as Background.....</i>	21
Figure 15	<i>Water surface as background.....</i>	21
Figure 16	<i>Influence of viewing angle on non-uniform daymarks.....</i>	22
Figure 17	<i>Direct illumination of a daymark (flat, cone, crossed plates).....</i>	23
Figure 18	<i>Recognition of simple shapes.....</i>	23
Figure 19	<i>Buoys with wings, forming the silhouette corresponding to the type of mark.....</i>	26
Figure 20	<i>Traditional cardinal buoys.....</i>	26



CONTENTS

Figure 21	Preferred buoy design to optimize visual performance.....	27
Figure 22	Superstructure and base body.....	27
Figure 23	Comparison of traditional and new generation buoy	27
Figure 24	Vertical stripe arrangement on a safe water buoy.....	28
Figure 25	Example of Safe Water Mark with Additional Wings.....	28
Figure 26	Additional parts on a buoy	29
Figure 27	Conflict between solar panels and cardinal marks.....	29
Figure 28	Optimized Cardinal buoys.....	30
Figure 29	Distribution of solar panels on a safe water mark.	30
Figure 30	Topmark proportions.....	31
Figure 31	Supporting structure used as a daymark.....	32
Figure 32	Red-white horizontal stripes.....	33
Figure 33	Rhombus design for the daymark of a light house.....	33
Figure 34	Alternative Colours for the daymark of a Lighthouse.....	33
Figure 35	White contrast painting for fixed lateral daymark buildings	34
Figure 36	Influence of the sun position on colour and shape recognition.....	35
Figure 37	Examples of a fixed structure daymark with unidirectional wings.....	35
Figure 38	White daymarks at the shore	36
Figure 39	Example geometry of a leading line dayboard.....	36
Figure 40	Daymarks defined by IALA Recommendation O-113.....	37
Figure 41	Preferred daymark design	37
Figure 42	Sign: best point of passage.....	38
Figure 43	Direction arrow, showing preferred design in the right hand picture.....	38
Figure 44	Resulting buoy shape for Example 1.....	41
Figure 45	Resulting buoy shape for Example 2.....	42
Figure 46	Resulting daymark shape for Example 3	43
Figure 47	Resulting design for Example 4 (units are in mm).....	44
Figure 48	Resultant design of Example 5	45
Figure 49	Statistical distribution of sky luminance, Baltic Sea 2003	48
Figure 50	Statistical distribution of water surface luminance, Baltic Sea 2003	48
Figure 51	Simple model of the eye	49
Figure 52	Simple fovea model	50
Figure 53	Stimulated cones for simple shapes	50
Figure 54	Blaise theory.....	51
Figure 55	Canadian standard daybeacon.....	52
Figure 56	Relevant dimensions of the daymark	52



CONTENTS

List of Equations

Equation 1	Geographical range	17
Equation 2	Luminous Contrast.....	19
Equation 3	Observation contrast	19
Equation 4	Observation contrast using atmospheric transmissivity	19
Equation 5	Observation contrast using meteorological visibility	20
Equation 6	Contrast for a single object.....	25
Equation 7	Deriving geographical range from height	42
Equation 8	Visible luminance.....	47
Equation 9	Movement of chromaticity	47
Equation 10	Spectral dependency of atmospheric light scattering	47
Equation 11	Angular separation of Fovea cones	49
Equation 12	Minimum value for shape identification	50
Equation 13	Solid angle for a large distance	51
Equation 14	Blaise theory ($\alpha < 0.8725$ mrad).....	51
Equation 15	Blaise theory ($\alpha > 0.8725$ mrad).....	51



1. INTRODUCTION

It is often considered that the installation of a visual signal consists of installing a light on a support structure, without conducting any kind of preliminary study on the daymark range, colour and other features of the daymark. It should not be forgotten that most traffic occurs during the day, which means that the daymark should be readily identified by mariners at a distance without possibility of confusion.

Existing IALA documents provide information on the proportions of daymarks but only limited information is given on the range at which daymarks can be effectively detected, recognised and identified.

This guideline provides a general informative overview of the main factors that need to be considered when providing and designing a daymark. It points out the aspects of visual perception and how to optimise the identification of a daymark. In practice financial and technical aspects can limit the provision of daymarks, thus the guideline describes a number of practical methods that can be adopted to achieve the most suitable solution to overcome these limitations.

Note

This guideline includes many illustrations and photographs. Due to the limitations of reproduction of colours by computer monitors and printers mean that these pictures are not representative of reality. It is advised not to use the pictures for visual trials or for the estimation of the visible performance of daymarks.

2. SCOPE

The scope of this document covers all those Aids to Navigation (AtoN) as defined in the IALA Maritime Buoyage System (MBS) [1].

This guideline does not cover the use of signs and lights as Aids to Navigation during daytime.

For information about daytime lights refer to the IALA Recommendation E-200 series [9].

For information about signs refer to the IALA Conference Presentation 1990 about lettering and signs [4].

The competent authority should ensure that structures and objects in the vicinity of fairways and waterways do not conflict with marks according to the IALA MBS.

If such structures include daymarks, these should be designed and maintained in accordance with the IALA MBS and this guideline.

If other structures or objects are designed and built in the vicinity of the waterway, conflict between these and the daymarks (according to the MBS and this guideline) should be avoided.

3. DEFINITIONS

The definition of terms used in this Guideline can be found in the International Dictionary of Marine Aids to Navigation (IALA Dictionary) at (<http://www.iala-aism.org/wiki/dictionary>).

4. DAYMARK TOPMARK BASIC PRINCIPLES

The visual task is to provide a daymark, according to the IALA MBS, that can be easily identified at a given distance, against a given or prevailing background. This means that the mariner can identify the shape, colour and colour combination.

The visible range of a daymark will be determined by the Competent Authority in an overall assessment of navigational requirement for the waterway or particular location.



A daymark's visible range with the naked eye will not necessarily be linked to the range of the associated light at night and will often be substantially less. However, the use of binoculars will greatly enhance the range at which a daymark can be identified. Typically, in the order of 8-10 times the range depending on the binoculars used.

A Daymark is defined by size, luminance, colour, shape and height above sea level. To estimate the visual performance, the background behind the daymark and the illumination by the sun have to be taken into account. Background and illumination depend on temporal, geographical and meteorological conditions. Reference background depends on the height of the vessel's bridge and direction of observation.

4.1. DEGREES OF PERCEPTION AND RANGE

When a navigator approaches a visual AtoN, for instance a buoy, the first thing the navigator will recognise is the shape or colour of the buoy depending on the viewing conditions.

The navigator will subsequently recognise the top-mark and finally its numbers or letters. Thus, the process of identifying a visual AtoN goes through three different stages of perception.

Table 1 *The three degrees of perception of daymarks*

Detection	The observer is aware of an object. The navigator sees an object, but will usually not be able to deduce its shape or colour and will not know that it is an AtoN.
Recognition	The observer is aware that the object is an AtoN.
Identification	The observer is aware which AtoN the object is. At this distance, the navigator can perfectly discern the type of mark it is.

The daymark range is the maximum distance at which the daymark can be seen according to a specific degree of perception. According to the different degrees of perception the daymark range does not have an exact definition.

As an optimum, the range should be defined on visual identification of the daymark (third degree of perception). However, for many daymarks it is acceptable to use a range definition, which is based on recognition. Using detection range should be avoided.

Note

In contrast to daymarks there is an exact definition for the luminous range of lights. This is based on Allard's law and an international convention about the threshold of illuminance.

4.2. INFORMATION PROCESS

The information process for daytime observation, as shown in Figure 1, has a number of parameters which influences visual perception. These can be defined as:

- **The Object:**
The object, as the signal source, can show different shapes and can be illuminated by direct or diffused sunlight or a combination of both. The background may be different depending on locations and may vary with time (weather, sun position).
- **The Media / Viewing Conditions:**
The atmosphere as the media has a certain value for meteorological visibility (e.g. haze, fog), which causes the light from the object to be scattered partially away from the line between the object and the observer. On the other hand, direct and indirect light is scattered partially into the observation line towards the observer.
- **The Observer:**

In general, the observer is limited by physiology. There are some agreements or conventions about the maritime observer - especially for commercial shipping. However, there are no exact values for visual perception in physiology and the convention may be different in each country.

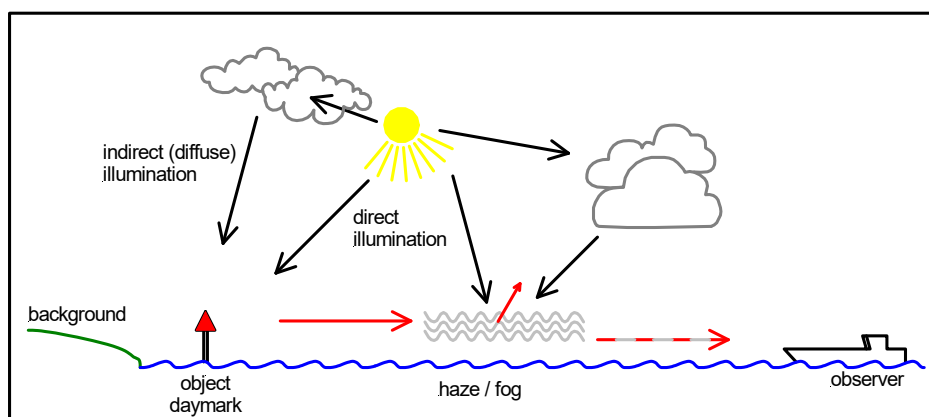

Figure 1 *Information process*

4.3. VISUAL PERCEPTION

There are two different aspects that affect visual perception that should be taken into consideration when designing a daymark.

- 1 The daymark has to be identified by a distant observer. The quality of the daymark can be described by the daymark range: the maximum distance where the daymark can be identified (under given conditions).
- 2 Local considerations should be taken into account so that the daymark is conspicuous in a complex background scene.

5. THE DAYMARK – OBJECT

5.1. PROFILE

The daymark has a 3-Dimensional (3-D) profile. When viewing the daymark, the user perceives a 2-dimensional (2-D) shape, which is a projection of the 3-D profile.

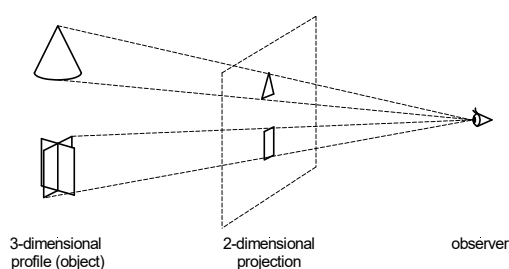

Figure 2 *Perception of an extended object*

The 3-D construction of the daymark profile is of significant influence on the 2-D shape seen from different directions.

For AtoN daymarks the following constructions are in use.

5.1.1. FLAT DAYMARK

A flat daymark can be used when the observer's position is nearly perpendicular to the surface. As there is only one surface element, which is orientated in a single direction, the surface looks uniform in all situations.

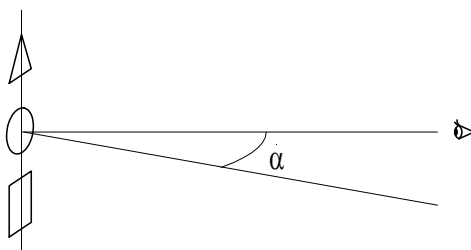

Figure 3 *Flat daymark and line between the vertical of the surface and the observer's direction*

The projected shape into the observer's direction changes with the angle between the vertical and the observer (Figure 4). Even for angles of 15° and 30° the shape can be identified. A flat daymark is the recommended construction for leading or range lines (range dayboards [5]).

They should be used for all other daymarks, when the angle of utilisation is 60° (+/-30°) or less. In these cases, considerations should be taken regarding the orientation of (flat) daymarks to shipping traffic.

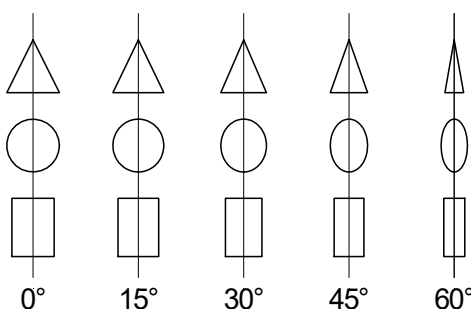

Figure 4 *Projected (visible) shape of a flat daymark*

5.1.2. SOLID DAYMARK WITH ROTATIONAL SYMMETRY

A daymark which shows the same shape in all horizontal directions must have rotational symmetry around the vertical axis. The three shapes of the IALA MBS are cylinders, cones and spheres. As the shapes are in 3D, the projected surface may not look uniform, due to shadowing as shown in Figure 5.

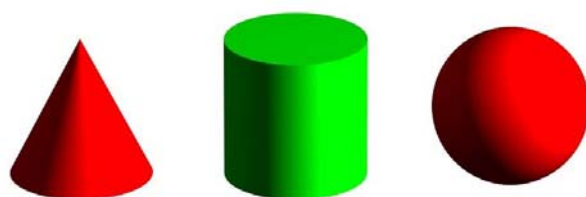

Figure 5 *Profiles with rotational symmetry*

Solid omni-directional daymarks can be used for short range. For higher ranges the size and the weight of a solid daymark limits its use. A compromise may be the use of crossed plates or a lattice construction.

Some competent authorities are investigating alternative materials for solid daymarks; for example, the Swedish Maritime Administration (SMA) is looking into using rubber or flexible plastic bristles to create daymarks that will be more resilient to severe ice conditions.

5.1.3. **CROSSED PLATES**

Crossed plates can be used for top marks and to enhance the buoy shape. They need less material, have a lower weight and are easy to manufacture. When the material is metal the crossed plates can act as a radar reflector as well.

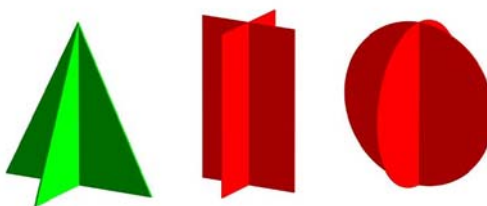

Figure 6 Profiles with crossed plates

5.1.4. **LATTICE CONSTRUCTION**

A lattice construction is similar to the three shapes above, but the structure is broken. It is generally used for large daymarks to reduce weight and wind load.

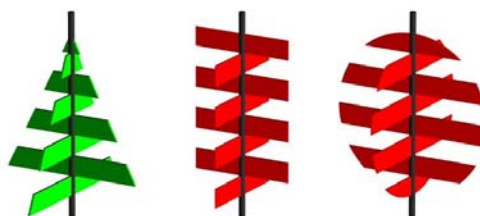

Figure 7 Lattice construction derived from crossed plates

The gaps (or voids) reduce the contrast of the daymark when it is viewed from a long distance.

Figure 7 shows crossed plates only, however, a lattice construction may be used for flat daymarks and for daymarks with rotational symmetry (Figure 8).



Figure 8 *Lattice construction of a lateral buoy*

As a general rule the projected surface of the solid area of a daymark should be greater than the gap.

5.1.5. COMPARISON OF 3D PROFILE

A flat daymark is the preferred design, because the whole surface appears in the same colour and brightness. However, it can only be used for a limited arc of utilisation (angle of observation).

The projected surface of a solid daymark will not appear uniform and might have shadow (Figure 5). Crossed plates show even more shadow and a lattice construction has less contrast.

Table 2 *Comparison of profiles*

3D profile	Visual performance	Limitation
Flat	best	Only for fixed AtoN
Solid	good	Best design for buoys
Crossed plates	acceptable	
Lattice construction	acceptable	Reduced contrast

5.2. LUMINANCE OF THE OBJECT

The luminance is the brightness of an object and is defined as the luminous intensity per unit projected area of any surface, as measured from a specific direction (see IALA-Recommendation E-200 On Marine Signal Lights, Part 3, Measurement).

It depends on its profile, its colour, the illumination of the object and the orientation of the surface elements. Parts of the daymark may have different luminance levels caused by different orientation or shadowing.

The luminance may change due to aging of the surface. In most cases ordinary colours tend to de-saturate resulting in a higher luminance. For fluorescent colours the luminance may become higher or lower depending on the specific material.

5.3. SURFACE COLOUR

5.3.1. SPECIFICATION

The Surface Colour is described by a luminance factor β and two chromaticity coordinates x, y (see IALA-Recommendation E-108 On Surface Colours).

The IALA MBS uses 6 Colours: Red, Yellow, White, Green, Blue and Black. The following figure shows the CIE standard chromaticity diagram and the location of the five colours (black and white are at the achromatic point).

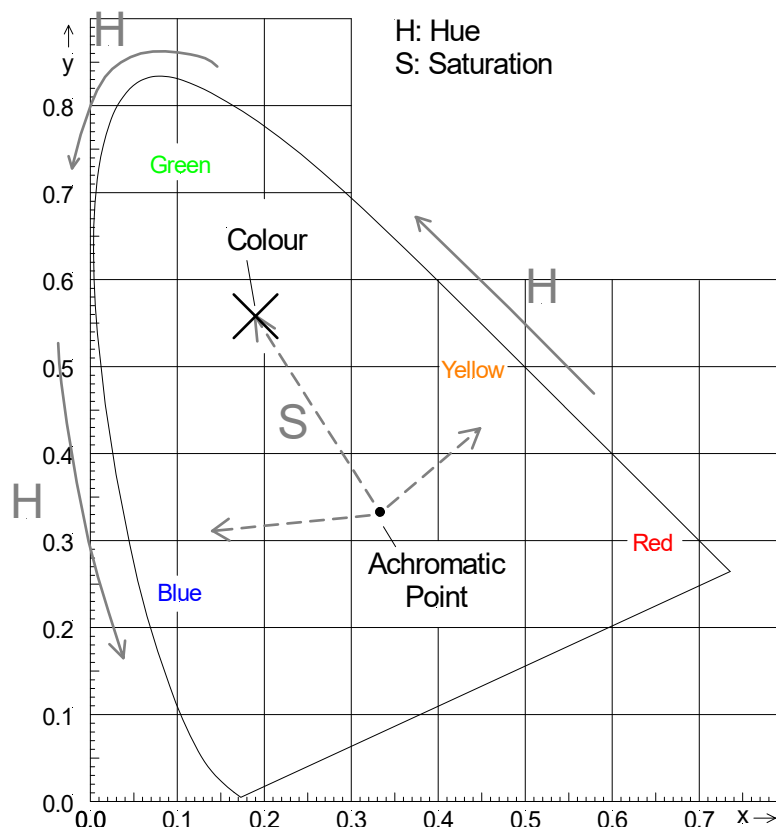

Figure 9 CIE standard chromaticity diagram

Note

Although there is a surface colour boundary for orange, it is not recommended for use as a surface colour due to its confusion with yellow and red.

The luminous factor and the chromaticity coordinates should fulfil the specifications of IALA Recommendation E-108 in order to be used according to IALA MBS. These specifications leave freedom to adjust the colour to a specific viewing condition.

A non-fluorescent colour (ordinary colour) can only reflect light that is incident on the surface. To produce a specific colour, the other spectral part of the incident light must be absorbed. To achieve a very saturated colour, the amount of spectrum absorbed becomes large and the reflected part very small. So a high saturation is only available for colours with low luminance. For ordinary colours a compromise between the levels for saturation and luminance has to be found.

For fluorescent colours a higher level for the luminance and saturation can be achieved.

For practical considerations it is better to describe the colour-by-colour collections. IALA currently supports two colour collections, which are known worldwide:

- Swedish Natural Colour System NCS;
- German RAL Colour.

The table shows the recommended colours according to the two collections. For further information, see IALA Recommendation E-108.

Table 3 *Values for the luminance factor β and Numbers of colour collections*

Colour	IALA Recommendation E-108					Maximum (fluorescent)
	Ordinary			Fluorescent		
	β	NCS	RAL	β	RAL	
Red	> 0.07	S 1085-Y80R	3028	> 0.25	3024	≈ 0.50
Yellow	> 0.50	S 1080-Y	1023	> 0.60	-	≈ 1.00
Green	> 0.10	S 2070-G10Y	6037	> 0.25	6038	≈ 0.50
Blue	> 0.07	S 4050-R90B	5017	-	-	-
White	> 0.75	S 0500-N	9016	-	-	-
Black	< 0.03	S 9000-N	9017	-	-	-

Surface Colour can be produced by:

- Films, sheeting;
- Paint;
- Plastic, coloured throughout.

5.3.2. AGING OF COLOUR

There are various aspects of colour aging. The deterioration of the colour may be caused by the following influences:

- fading of the colour pigment due to ultra violet degradation;
- mechanical abrasion of the surface;
- fouling and bird droppings (the colour is hidden under a natural cover).

The fading of the colour pigment often results in a desaturation of the colour. This means it moves towards the achromatic point.

5.3.3. RETROREFLECTIVE SHEETING

A retroreflective surface should not be used for daymarks throughout. The retroreflective principle works only when the surface is illuminated at night with a searchlight near the observer. In daylight, the retroreflective colours show low luminance and are not very conspicuous.

For this reason, the industry has introduced retroreflective-fluorescent films. However, the colours available are made for road traffic and there is not a complete set of films for the IALA MBS colours.

Retroreflective films can be used for some small parts of an unlighted buoy, so the mariner can detect the position and colour at night by use of a searchlight.

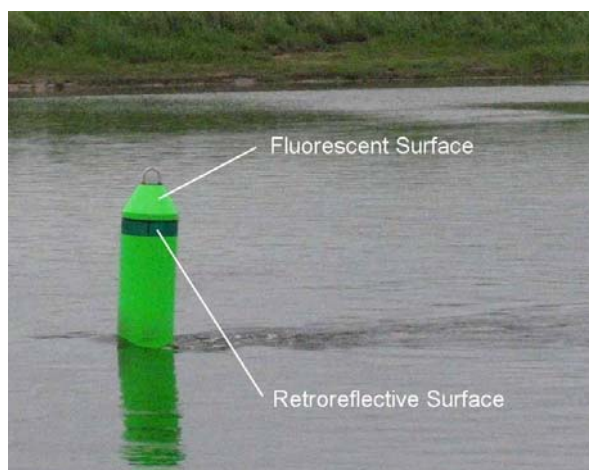

Figure 10 *Typical application for retroreflective sheets on a buoy*

5.4. SIZE

The size of a daymark is directly linked to its range. As stated in section 5.1 the observer sees a projection of the real object and the lateral dimensions of this projection are relevant for the estimation of the daymark range.

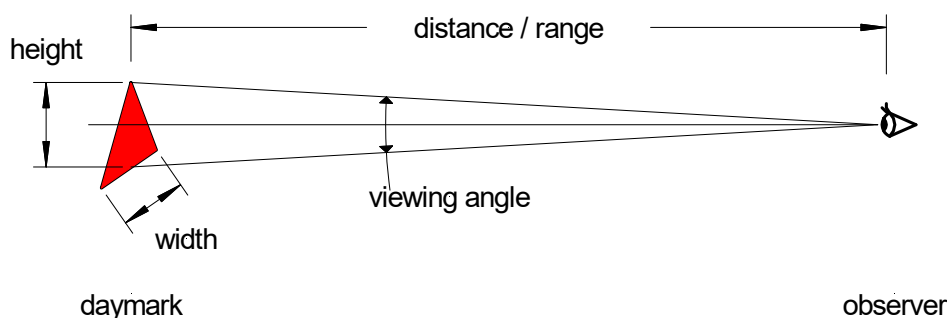

Figure 11 *Lateral extension and range of a daymark*

The angular subtense α (viewing angle) of the daymark can be calculated by:

- α [radians] \approx height / distance (for the vertical angle);
- α [radians] \approx width / distance (for the horizontal angle).

With these formulae it can be shown that the range of the daymark depends on the minimum useful viewing angle α_{\min} assigned to the daymark:

- Range \approx (lateral dimension) / α_{\min} [radians];
- Lateral dimension: height or width.

The minimum useful viewing angle for a specific daymark depends on all the parameters mentioned in section 4.2. There are different conventions for this angle.

For symbols and letters an IALA publication was presented at IALA-conference 1990, which includes a convention about the minimum useful viewing angle for many CEVNI and SIGNI signs [4].

5.5. COMBINATION OF COLOURS

Many daymarks of the IALA Maritime Buoyage System consist of a combination of colours e.g. cardinal or isolated danger marks.

For the identification of the daymark the stripe colour configuration must be able to be recognized.

In Figure 12 the vertical size of the object is seen as the limiting factor for the range of the daymark. At the range d the single coloured object appears under a viewing angle of α for the observer. When the same object has multiple colours to show an isolated danger mark, the observer has to recognize each stripe in the same manner as the single coloured object.

So even though the height of the two daymarks are the same, the range of the isolated danger mark will only be one third of the single coloured lateral mark, due to overall size of the single colour and higher luminance of the red stripe.

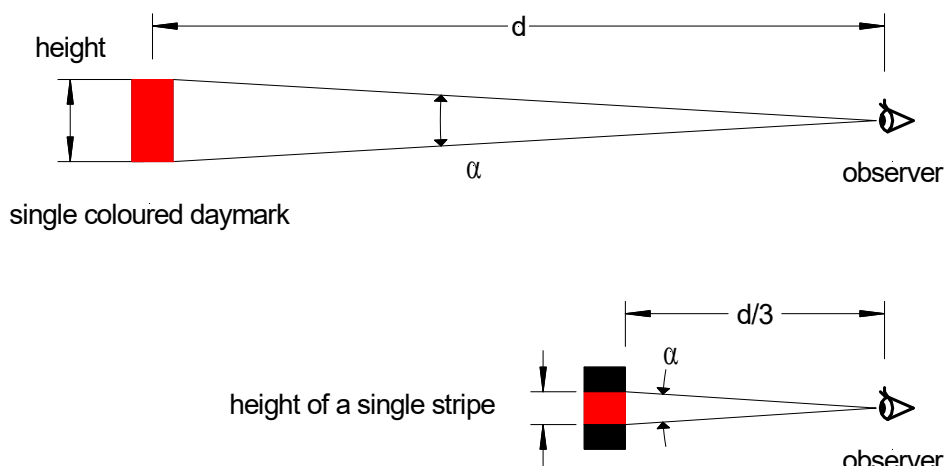

Figure 12 *Single and multi coloured daymarks*

Although this calculation is not exact, because the horizontal dimension was not regarded, it can be stated generally:

The range of a multi coloured daymark is significantly lower than for a single coloured daymark of the same size.

6. THE VIEWING CONDITIONS – MEDIA

6.1. VIEWING DISTANCE

The first aspect of viewing conditions is the distance between the daymark and the observer and their vertical position. Because of the curvature of the Earth the daymark must have a certain height to be seen above the horizon.

The minimum height $h_{b,min}$ of the lowest part of the daymark is given by the formula for geographical range R_g .

$$R_g = 2.03 \times (\sqrt{h_o} + \sqrt{h_{b,min}})$$

Equation 1 Geographical range

Where:

R_g = geographical range (nautical miles)

h_o = elevation of observer's eye (metres)

h_b = elevation of the base of the daymark (metres)

The constant is to allow for the curvature of the Earth and Atmospheric factors [18]. Climatic variations around the world may lead to different factors being recommended. The typical range of factors is 2.03 to 2.12.



If there are actual or potential obstructions between the observer and the daymark, then the height may have to be modified to allow for this obstruction.

Table 4 shows some examples of ranges that can be achieved given the elevation of the observer and the elevation of the base of the daymark being observed.

Table 4 Geographical Range in Nautical Miles (M)

Observer's eye height (metres)	Elevation of Daymark (metres)								
	0	1	2	3	5	10	20	30	50
3	3.5	5.5	6.4	7.0	8.1	9.9	12.6	14.6	17.9
5	4.5	6.6	7.4	8.1	9.1	11.0	13.6	15.7	18.9
10	6.4	8.4	9.3	9.9	11.0	12.8	15.5	17.5	20.8
20	9.1	11.1	11.9	12.6	13.6	15.5	18.2	20.2	23.4
30	11.1	13.1	14.0	14.6	15.7	17.5	20.2	20.2	25.5
40	12.8	14.9	15.7	16.4	17.4	19.3	21.9	24.0	27.2
50	14.4	16.4	17.2	17.9	18.9	20.8	23.4	25.5	28.7

In most situations the daymark's visual range is less than the luminous range at night and so many daymarks are used for short-range navigation only. The geographical range of a daymark is often much larger than the daymarks visual range. Therefore, the geographical range of a daymark is not critical in the design process.

6.2. METEOROLOGICAL VISIBILITY

The meteorological visibility is a way to describe the atmospheric extinction of light by the atmosphere.

Definition (IALA dictionary):

2-1-280 Meteorological Visibility

The greatest distance at which a black object of suitable dimensions can be seen and recognised by day against the horizon sky, or, in the case of night observations, could be seen and recognised if the general illumination were raised to the normal daylight level. The term may express the visibility in a single direction or the prevailing visibility in all directions.

The meteorological visibility is not the daymark range. The definition describes a method of how to estimate the visibility of the atmosphere. The object must be black to ensure maximum contrast against the sky at day and it must be very large to provide a sufficient viewing angle for the observer. In practice a mountain with forest or a dark building can be used.

An AtoN daymark has a colour according to the IALA MBS and therefore a smaller contrast than black. The size of the daymark is limited as well. From this point of view, it can be stated generally:

The range of a daymark is always less than the meteorological visibility.

6.3. KOSCHMIEDER'S LAW

One parameter relevant for the visibility of an object is the apparent contrast of an object at the position of the observer (observer contrast).

The contrast C is defined by (see IALA dictionary):

$$C = \frac{L_o - L_b}{L_b}$$

Equation 2 Luminous Contrast

Where

C is the apparent contrast of an object against a sky background

L_o is the Luminance of the object

L_b is the Luminance of the background

In Figure 13 the scattering of light in the atmosphere is illustrated. Some amount of the (coloured) light which moves in the direction of the observer is scattered by the atmosphere into a different direction and gets lost (1). Some light (from background or sun light) is scattered into the direction of the observer (2).

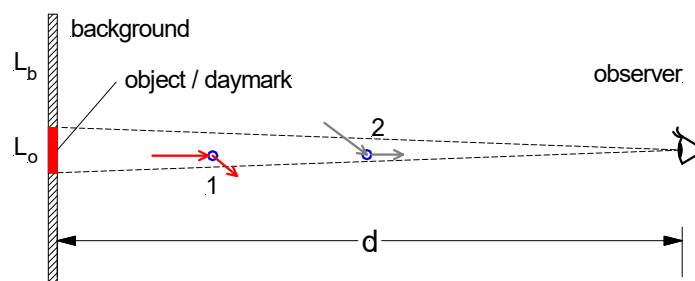

Figure 13 *Simplified illustration of light scattering in atmosphere*

Koschmieder's law says that the observation contrast at a distance d is:

$$C(d) = C(0) \times e^{-z*d}$$

Equation 3 Observation contrast

Where:

C_o , the photometric contrast is the contrast without taking into account atmospheric extinction. It is measured directly in front of the daymark.

C_d , the observation contrast, is the contrast as seen by a distant observer and takes in to account atmospheric extinction.

z is the exponential factor (total attenuation includes absorption and scattering)

d is the distance

According to IALA E-200-2 the formula can be expressed by using the atmospheric transmissivity T_M .

$$C(d) = C(0) \times T_M^d$$

Equation 4 Observation contrast using atmospheric transmissivity

Where:

C_d is the observation contrast

T_M is the transmissivity for 1 nautical mile



d is the distance in nautical miles

When the meteorological visibility V is used the formula becomes:

$$C(d) = C(0) \times 0.05^{d/V}$$

Equation 5 Observation contrast using meteorological visibility

Where:

V is the meteorological visibility in nautical miles

d is the distance in nautical miles

Although Koschmieder's law is accepted as the basis for many calculations it must be stated that it is based on a very simple physical model. The atmosphere must be homogenous and the illumination must be uniform and diffuse.

Especially for direct sunlight illumination, Koschmieder's law is not very exact because the amount of light scattered into the observer's direction depends on the sun position.

A physical description of Koschmieder's law is presented in ANNEX A.

6.4. BACKGROUND

The contrast C depends on the Luminance of the daymark and the background in its vicinity, so the visual detection of the daymark is strongly influenced by the background.

The background can be divided into 3 main groups:

- water surface near the horizon;
- sky near the horizon;
- shore with different landscapes or buildings.

All the backgrounds may change with weather conditions and season.

To expand on the above:

Water surface:

- changes with wind and waves;
- ice in winter;
- sun light reflections.

Sky:

- blue sky, red sky;
- clouds;
- sun behind daymark.

Shore:

- vegetation in summer and winter;
- snow.

As the daymark is static some assumptions have to be made about which background will be dominant over time.

6.4.1. SKY AS THE BACKGROUND

For small ships the daymark may appear before the horizon sky.

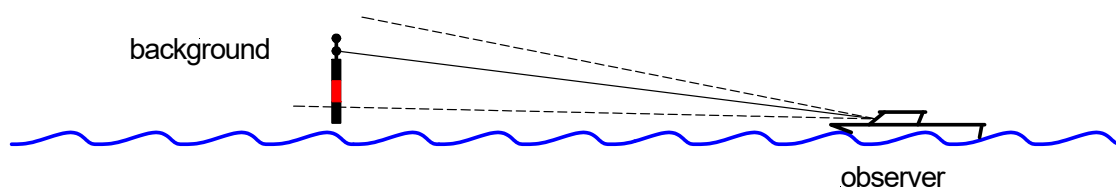

Figure 14 Sky as Background

Although topmarks are limited in size, black topmarks of the IALA cardinal and isolated danger marks have best contrast (black topmark in front of bright sky).

6.4.2. SUN BEHIND A DAYMARK

The recognition of a daymark when the sun is visible in the vicinity at sunset or sunrise is poor. In many situations colours and symbols cannot be recognized. However, the shape (outline) of the daymark can be identified.

6.4.3. WATER SURFACE AS BACKGROUND

For large vessels and floating aids the vertical position of the observer is much higher than the position of the daymark so that the background for observation is the water surface.

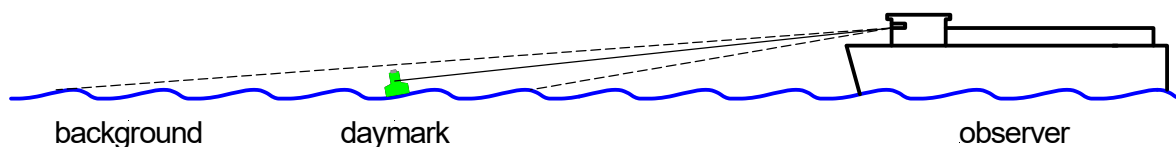

Figure 15 Water surface as background

A smooth water surface acts as a perfect mirror for flat incident angles. However, because of the roughness of the sea due to wind and waves, the luminance of the water surface is lower than that of the sky.

Measurements in the Baltic Sea showed that the luminance of the water surface is approximately 50% of the sky luminance at the horizon (see ANNEX B).

6.4.4. LANDSCAPE AS BACKGROUND

When the landscape or shore is the background of the daymark, the contrast depends on the 'albedo' or reflectance of the landscape. As for the water surface the landscape appears darker than the sky in most situations. In most cases the albedo value is identical to the luminance factor (see [14]).

Table 5 Albedos for different surfaces [15]

Surface	Typical albedo
Asphalt	0.04 - 0.12
Forest	0.08 - 0.15
Bare soil	0.17
Green grass	0.25
Desert	0.40
New concrete	0.55
Ocean ice	0.5 - 0.7
Fresh snow	0.8 - 0.9

7. THE OBSERVER

7.1. EYE RESOLUTION AND SUBTENSE ANGLES

A simple model of the human eye is presented in ANNEX C.

For very good vision the observer might be able to resolve objects that appear smaller than 1' (arc minute), but he is not able to identify them. Therefore, the minimum useful viewing angle should be larger than 1'.

This means:

1 arc minute is the lower limit for any useful viewing angle of a daymark.

7.2. NON-UNIFORM DAYMARKS

One consequence of the limited eye resolution is the visual perception of a lattice construction or a 2-colour daymark.

As already stated, the quality of a daymark for AtoN depends on how it can be identified from a long distance. The daymark will appear smaller when seen from afar.

The consequence is shown in Figure 16 for 3 different daymarks: a solid green square, a red lattice construction and a 2-colour daymark with red and green.

From a long distance the stripes of the lattice construction will melt together with the grey background. For the 2-colour daymark the red and green part will melt together as well.

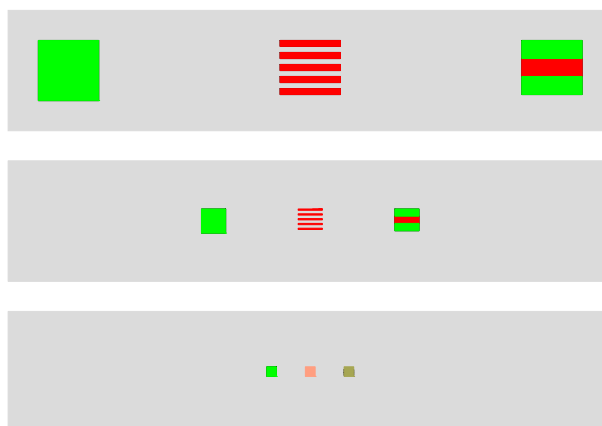

Figure 16 *Influence of viewing angle on non-uniform daymarks*

In both cases the observed contrast at a long distance will become the mean value over the whole daymark projection. For the lattice construction this will immediately reduce the contrast, e.g. if the lattice and the gap are of same size the contrast is half the value of a single lattice.

The colour of the daymark seen from afar will be the mixture of the individual colour of the elements. For the lattice construction red and grey are mixed to an unsaturated red. Green and red produce a brown colour (dark yellow).

The solid daymark will appear the same at every distance until it vanishes.

From this point of view, a solid and single coloured daymark has the best visual performance (see also section 5.5).

When illuminated by direct sunlight the 3-D surface elements of a daymark can emit different luminance (Figure 17).



Figure 17 Direct illumination of a daymark (flat, cone, crossed plates)

Whereas the flat daymark shows a uniform surface to the observer, the projected surfaces of the other designs break down into different regions with lower and higher luminance. The eye tends to prefer the brighter surfaces so that the effective projected surface is smaller for the cone and the cross plates.

7.3. SHAPE RECOGNITION

In Figure 18 it is shown that for the recognition of simple shapes the viewing angle needs to be larger than 1' (eye resolution).

As a rule of thumb the projection of a simple shape should appear at a minimum subtense angle of about 3' (= 0.873 mrad) to provide identification. For safety reasons this value may be increased.

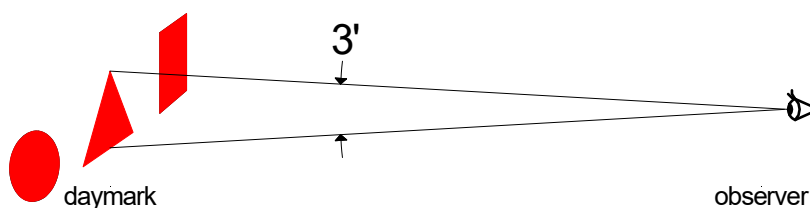
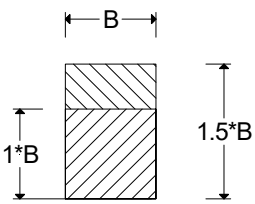
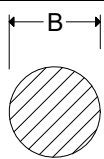
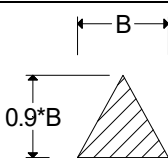

Figure 18 Recognition of simple shapes

Some conventions about daymark range (DR) of simple shapes are shown in the table below.

Table 6 Conventions on range and minimum viewing angle

Object	Dimension	1 (Brazil)	2 (IALA 1983)	3 (Germany)
Cylindrical		4,1' DR = 833 * B	6,9' DR = 500*B	3' DR = 1146*B
Spherical		4,1' DR = 833 * B	6,9' DR = 500*B	3' DR = 1146*B
Conical		2,75' DR = 1250 * B	6,9' DR = 500*B	3' DR = 1146*B

- 1 Manual de Sinalização Náutica of the Brazilian lighthouse service [17].
- 2 IALA Maritime Buoyage system guidelines 1983 and IALA NAVGUIDE [10].
- 3 German paper 1987, [18].

Table 7 shows typical values of daymark range for the given viewing angle.

Table 7 Typical values of daymark range

Operational Range		Lateral dimension in metres [m]				
[km]	[M]	Viewing angle				
		1' (0.291 m rad)	2' (0.582 m rad)	3' (0.873 m rad)	4' (1.16 m rad)	5' (1.45 m rad)
1	0.54	0.29	0.58	0.87	1.16	1.45
2	1.08	0.58	1.16	1.75	2.32	2.91
3	1.62	0.87	1.75	2.62	3.48	4.36
4	2.16	1.16	2.33	3.49	4.64	5.82
5	2.70	1.45	2.91	4.37	5.80	7.27
10	5.40	2.91	5.82	8.73	11.64	14.54
15	8.10	4.36	8.72	13.09	17.45	21.82

7.4. REQUIRED CONTRAST

For a single object the contrast is defined by (see 0)

$$C = \frac{L_o - L_b}{L_b}$$

Equation 6 Contrast for a single object

Where:

L_o = Luminance of the object

L_b = Luminance of the background

Under ideal conditions a contrast of 0.02 is sufficient for the detection of a large black object before horizon sky (see IALA dictionary). For practical observation it was agreed to put the required minimum contrast to a value of 0.05.

For a large observation distance and for coloured daymarks not seen before the sky the required contrast needs to be much higher than 0.05.

A theory about the required contrast for small objects depending on the viewing angle was given by M. P. Blaise in IALA bulletin April 1971 (see ANNEX D). However, this theory is based on simple detection and not recognition and does not include the colour difference to the background.

7.5. COLOUR RECOGNITION

The colour recognition depends on the:

- brightness of the colour;
- hue;
- contrast to the background;
- colour difference to the background.

In most situations the background appears nearly grey, so that the colour difference depends on the saturation of the daymark only.

Colour recognition is better when there is a dark background.

When the background is very bright (e.g. sunset - sunrise) colour recognition is poor.

The required hue and saturation are defined by the regions of IALA Recommendation E-108 For the surface colours used as visual signals on aids to navigation (specifications for ordinary and fluorescent colours). These regions are based on considerations about the physiological features of the eye.

8. DESIGN OF DAYMARKS

8.1. FLOATING AIDS

For floating aids (mainly buoys) the following aspects should be considered:

8.1.1. 3-D PROFILE

The preferred 3-D profile has rotational symmetry around the vertical axis and is solid, so the projected shape appears equal for nearly all positions around the buoy. Crossed plates and lattice construction can be used to reduce weight and cost, but perform less effectively for visual perception.

8.1.2. COLOUR

For buoys the background is arbitrary: it may be the water surface, the horizon sky or the landscape. Therefore, it does not make sense to adjust the colour's brightness. Instead the buoy's colours should be standardized where highly saturated and bright colours are preferred.

The standard may include two qualities, for example, ordinary colours for average areas, fluorescent colours to provide high conspicuity for difficult areas. Standardized colour collections for buoys can be found in IALA Recommendation E-108.

8.1.3. SIZE AND SHAPE OF SINGLE COLOURED BUOYS

A coloured buoy may be seen even when it has (luminance) contrast of zero to its background.

The minimum angular subtense of a single coloured buoy should be 3'. For safety reasons a value of 4' or 5' may be chosen to define the daytime range and to calculate the required size of a buoy.

In many cases it is accepted that the height of a buoy shape is greater than the width with a ratio e.g. of 3:1 (see [13] & [18]). This leads to the traditional buoy shapes.

To improve shape recognition additional wings may be introduced to the buoy structure (Figure 19). In this case the shape of lateral and spherical buoys should be similar to the associated topmark. However, where this is not practicable an attempt should be made to provide the closest representation of the required shape according to the MBS.

The daymark's range can be determined with Table 7, in section 7.3.



Figure 19 Buoys with wings, forming the silhouette corresponding to the type of mark

8.1.4. SIZE AND SHAPE OF CARDINAL-BUOYS

The recognition of a cardinal buoy is based on either the recognition of the yellow-black stripes or the top mark (two cones). In most cases the body of the buoy is larger than the topmark, so the range for the 'stripes' is larger than the topmarks.

As shown in 5.5 the daymark range of a 2-colour buoy is significantly less than that of a single colour buoy.

A typical design of a cardinal buoy is shown in the next figure. The three stripes appear with different sizes according to the different diameters of the buoy.

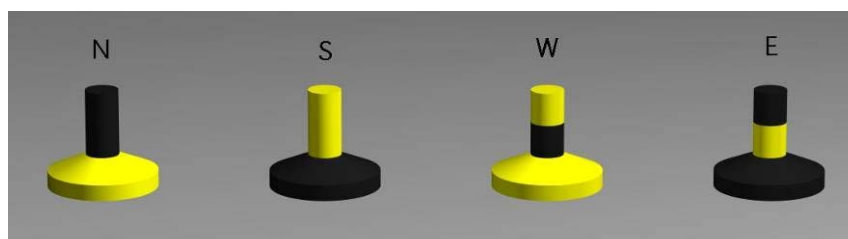

Figure 20 Traditional cardinal buoys

When the observer moves away from the buoy the stripes become smaller and will disappear at the eye's resolution. As they are different in size, each stripe has its own range. At these distances the daymark of the buoy may be misleading, for example the observer sees a yellow dot only for cardinal north and west and identifies a special mark.

To prevent this situation the preferred cardinal buoy presents each stripe in the same size as shown in Figure 21.

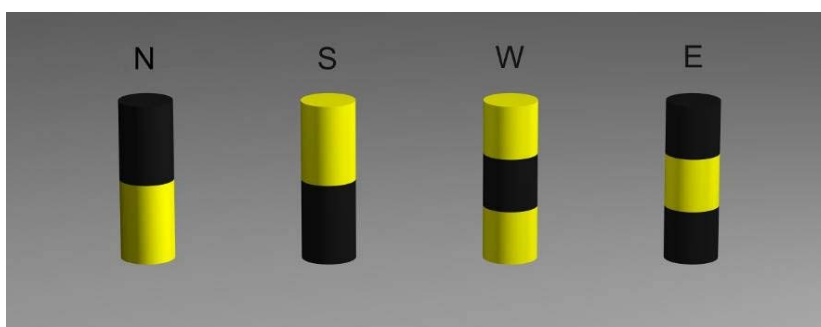

Figure 21 Preferred buoy design to optimize visual performance

The superstructure, which is the day mark of the buoy, should sit on the base body, which may be light grey or the colour appropriate for the day mark.

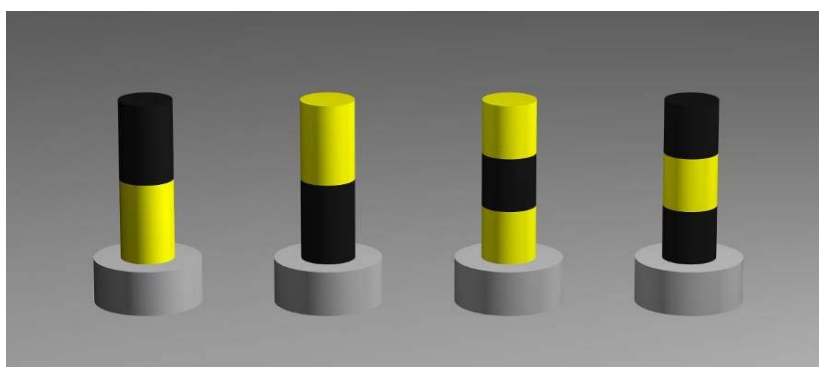

Figure 22 Superstructure and base body

The influence on the buoy shape for cardinal marks was investigated by the French administration when they switched from a classical buoy shape to cylindrical shape (Figure 23).



Figure 23 Comparison of traditional and new generation buoy

It was confirmed by visual trials that the cylindrical shaped cardinal buoys increased the daymark range of the buoys significantly.

8.1.5. SAFE WATER AND NEW-DANGER MARKS

In the IALA MBS these marks show vertical stripes. The number of stripes is not fixed and three main arrangements for the stripes have been used.



Figure 24 Vertical stripe arrangement on a safe water buoy

Whereas the arrangement '8 x 45°' is very conspicuous for short range, the width of the stripe should be larger to enhance daymark range. For the arrangement '4 x 90°' only one stripe is completely visible in one direction. For '6 x 60°' there is always a red and a white part visible. Regarding the daymark range, the optimum arrangement is '6 x 60°'. Figure 5 shows a good example of how to achieve the shape of a safe water mark using additional wings.



Figure 25 Example of Safe Water Mark with Additional Wings

8.1.6. STRUCTURAL OBSTRUCTIONS

In practice, a buoy needs additional equipment, which might cause conflict with its daymark function, for example an eyelet, screws, bolts, a ladder, a lantern or solar panels.

The task is to minimise the negative effect of all these additional parts.

This can be achieved with the following measures:

- as far as possible, the additional parts should show the same colour as the buoy;
- when the position of the part may be moved, it should be moved such that it does not compromise the navigational characteristics of the buoy;

- if the colour of the additional equipment cannot be chosen to be the same as for the buoy it should be a light grey (e.g. RAL 7042).

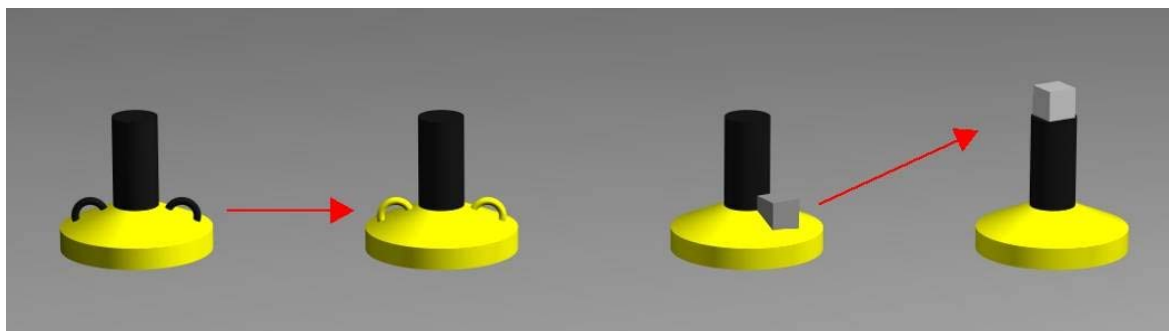

Figure 26 *Additional parts on a buoy*

8.1.7. SOLAR PANELS

Solar panels are the most significant structural obstruction on a lighted buoy. The colour of the solar panel is often a dark blue, which appears black from a long distance. Coloured solar panels are available but their electrical efficiency is very low and, therefore, they are not suitable.

The dark blue panels may obstruct the identification of a cardinal buoy. For example, if an arrangement of panels is set on the top of a cardinal south buoy, it may be appearing as an east cardinal.

To avoid this, the solar panels should be positioned in the black part of the cardinal buoy.

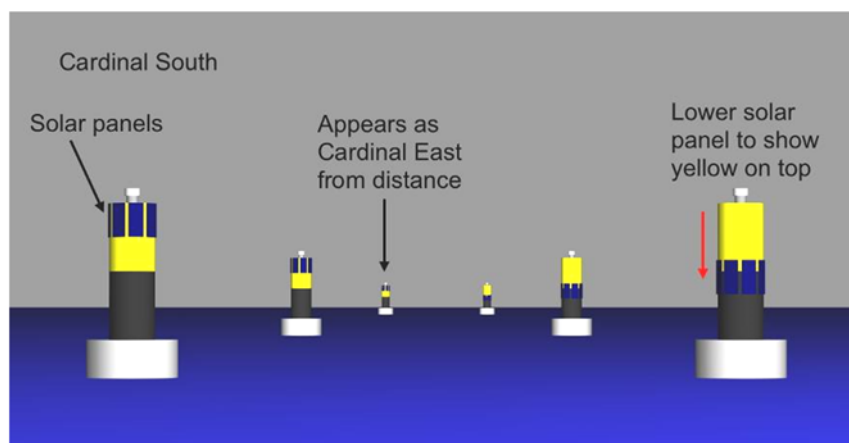

Figure 27 *Conflict between solar panels and cardinal marks*

The following photographs show examples of well-designed cardinal buoys. In the left picture the shape has been made cylindrical and the black and yellow stripes are of the same size. The solar panels are located in the black part of the buoy's daymark. The lower part is grey and is therefore neutral. To minimize the wind force a lattice construction is used. The right picture shows a buoy with additional wings to increase the visible surface of the daymark.



Figure 28 *Optimized Cardinal buoys*

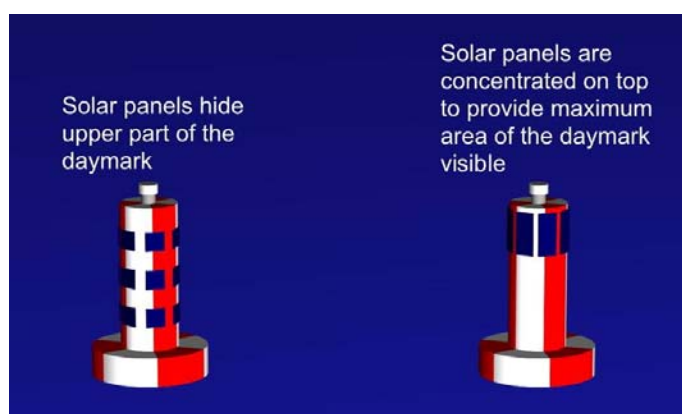

Figure 29 *Distribution of solar panels on a safe water mark.*

Figure 29 shows that the positioning of the solar panels is important to maximize the daymark's characteristics.

8.1.8. TOPMARKS

In general, topmarks of buoys are significantly smaller than the buoy itself. So the visual range of the topmark is shorter as well.

However, topmarks play an important role in confirming the AtoN characteristics through the use of binoculars or when one is at a distance below the recognition distance of the AtoN as a whole.

Topmarks are optional on all kinds of buoys, but for cardinal and isolated danger marks IALA MBS strongly recommends the use of topmarks.

Buoys can be used in locations exposed to annual drifting ice, possibly of considerable thickness, that can destroy equipment mounted on the buoy body. The use of topmarks may not be feasible in these situations.

8.1.8.1. Shape

The shapes used in the IALA-MBS include cones, spheres, cylinders, X shapes and crosses (new danger mark). They can be made with the profiles shown in 5.1.

8.1.8.2. Dimensions

The dimensions should be as large as possible, taking into account the impact on the buoy's stability. The IALA Maritime Buoyage System Guidelines [11] describe the relationship between the topmark and the buoy size. Dimension X as shown in Figure 29 was originally defined as 25% to 30% of the buoy's diameter. However, a more practical figure is 15% to 25%.

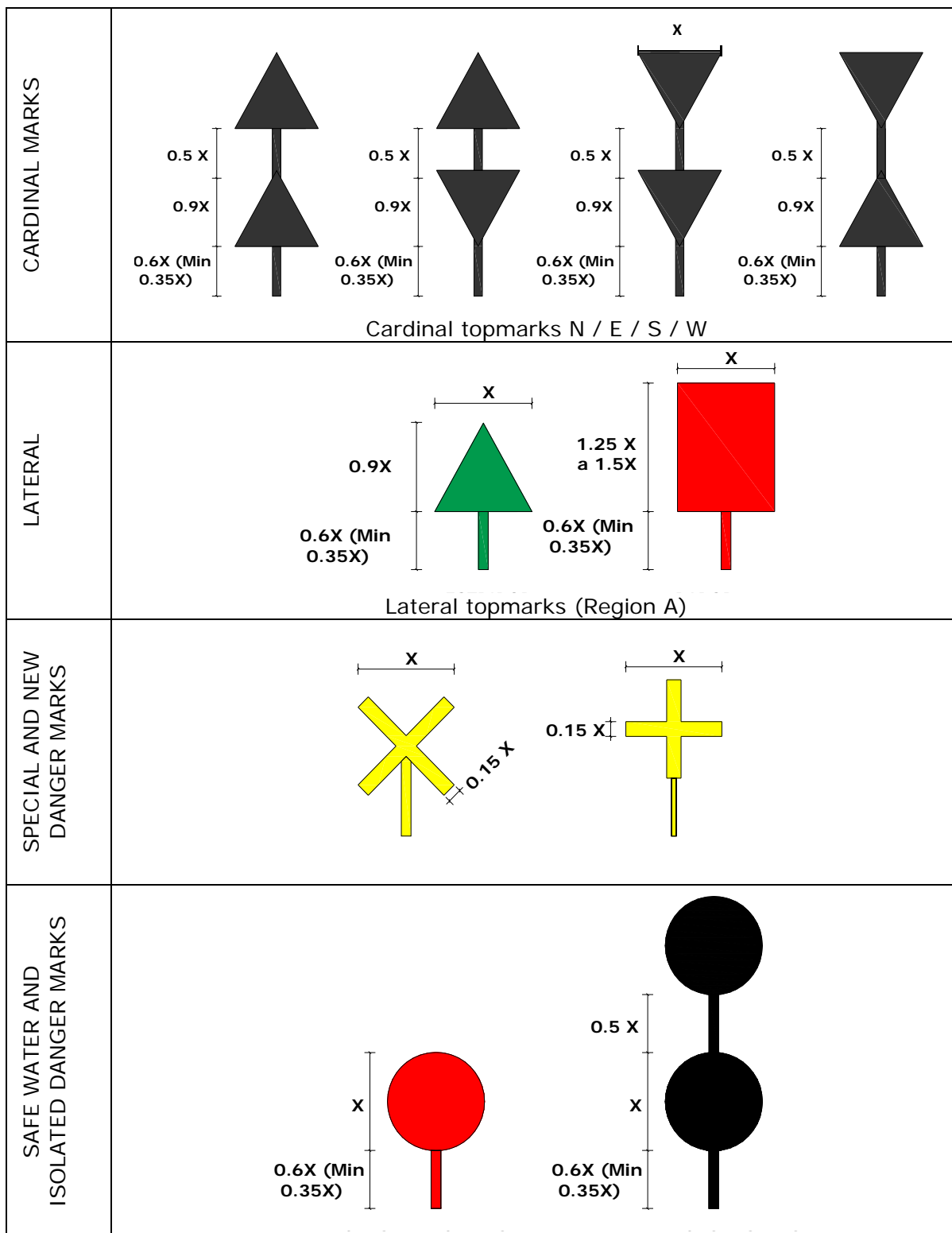

Figure 30 *Topmark proportions*

8.2. FIXED AIDS

Nearly all markings defined by IALA MBS for buoys, are used for fixed aids. So the information given above for buoys may be used for fixed aids.

However, for floating aids there are a lot of design limitations caused by the floating features and maintenance aspects.

For fixed aids there is more freedom in the design of daymarks.

For example:

- A fixed daymark may be much larger and higher providing a long daymark range;
- A specific colour scheme may be used to identify a particular fixed aid;
- It may be flat;
- It may be designed for a specific background;
- It may have a background panel to show more contrast;
- The design of the daymark should take into consideration environmental conditions such as wave action or ice;
- The supporting structure of a daymark may become part of the daymark or be used to enhance the conspicuity (Figure 31).



Figure 31 Supporting structure used as a daymark

8.2.1. TRADITIONAL LIGHTHOUSES

The use of stripes is a traditional method to increase the conspicuity of lighthouses as daymarks. Regarding the daymark range, the buildings should have a single colour to make the range as large as possible. A colour combination red-white is used to enhance conspicuity while accepting a reduced daymark range.

Because of its high conspicuity the colour combination red-white is widely used for aeronautical daymarks and road traffic signs as well.



Figure 32 Red-white horizontal stripes

A colour combination can also be used to identify a daymark. For this reason, special geometrical design (e.g. rhombus) or a different colour combination (green-white) can be used.



Figure 33 Rhombus design for the daymark of a light house



Figure 34 Alternative Colours for the daymark of a Lighthouse

Some colour combinations should not be used arbitrarily. This is because the IALA MBS has already defined some colour combinations for specific nautical information.

These are:

- green-red horizontal bands for channel division;
- black-red horizontal bands for isolated danger marks;
- black-yellow horizontal bands for cardinal marks;
- white-red vertical stripes for safe water marks;
- blue-yellow vertical stripes for new-danger marks.

These colour combinations should only be used for fixed aids if the daymark has the same nautical meaning as the corresponding buoy.

8.2.2. ADDITIONAL TOOLS FOR STRUCTURES USED AS DAYMARKS

In order to facilitate colour recognition, mainly in the case of lateral marks, it can be useful that the lower part of the structure is painted white. The contrast with the surrounding and the upper part of the building, which shows the colour, can be enhanced.

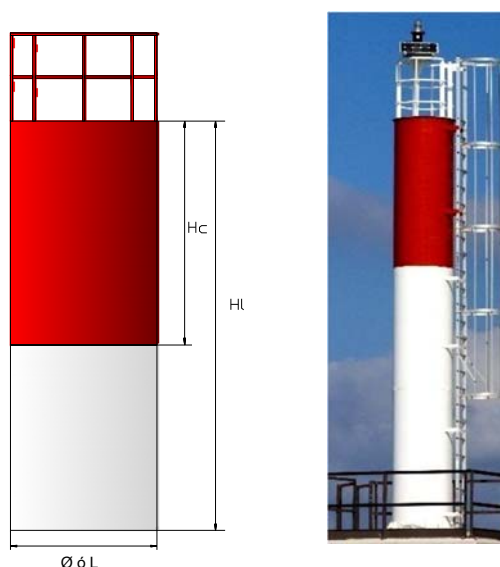

Figure 35 *White contrast painting for fixed lateral daymark buildings*

Only the dimensions of the part painted in the colour corresponding to the type of signal should be used to calculate a daymark's useful surface area.

The installation of a topmark or a specific shape for the building corresponding to the IALA MBS greatly enhances the recognition of the daymark. Shape recognition is very important at backlight situations at certain times of the day, because in backlight situations the colour recognition is poor (see Figure 36).



Figure 36 Influence of the sun position on colour and shape recognition

In some cases, the structure may incorporate a projected profile of the specific IALA MBS mark. This can be achieved in ways such as omni or unidirectional wings or panels (Figure 37).



Figure 37 Examples of a fixed structure daymark with unidirectional wings

8.2.3. WHITE DAYMARKS

The luminance factor or albedo (see 6.4.4) of the background (rock, forest) is often in the range between 0.05 and 0.2. So except for white, the standard colours green and red have approximately the same value and, therefore, provide only a low luminance contrast (see 5.3.1).

For this reason, a white daymark is preferred in situations when the shore is the background and the design can be chosen free from the constraints of the IALA MBS.



Figure 38 *White daymarks at the shore*

However, a white daymark shows very low contrast in foggy viewing conditions and when the background is covered with ice or snow.

8.2.4. DAYBOARD OF LEADING LINES

The daymarks of leading lines are described in IALA Guideline 1023 [5]. As leading lines are used in a small horizontal sector only, the daymark should be flat. The Guideline proposes a dayboard with white and red vertical stripes.

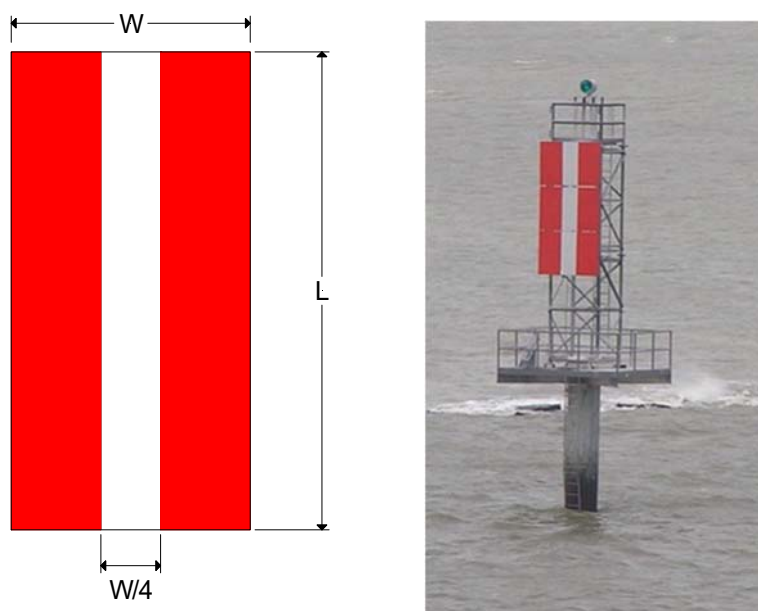

Figure 39 *Example geometry of a leading line dayboard*

Depending on the vertical height (Length) of the daymarks the guideline defines an operational range. The operational range is therefore the daymarks range for this specific daymark layout. For good viewing conditions (meteorological visibility 10 M) the operational range depends on the size (L = length) of the dayboard only.

Table 8 *Dayboard size and range*

Dayboard Size L x W [m x m]	Operation Range [km]	Operation Range [M]	Viewing angle for length L	Viewing angle for width W (= L / 2)
1.6 x 0.8	1.9	1	2.9'	1.5'
2.1 x 1.05	3.7	2	2.0'	1.0'
3.1 x 1.55	5.6	3	1.9'	1.0'
4.2 x 2.1	7.4	4	2.0'	1.0'
6.3 x 3.15	9.3	5	2.3'	1.2'
8.6 x 4.3	11.1	6	2.7'	1.3'
12.2 x 6.1	13.0	7	3.2'	1.6'

The viewing angles of the vertical and horizontal size of the dayboard at maximum range can be compared to the values in 0. Because of the long range required and the resulting large dayboards the accepted minimum viewing angles are smaller than for buoy topmarks.

However, the dayboard of a leading line does not need shape recognition. At great distance the observer will see the dayboard as a small red vertical bar. The white stripe may disappear because it is already smaller than the eye resolution.

8.2.5. MARKING OF BRIDGES

Another example of a flat daymark is the marking of bridges as defined in IALA Recommendation O-113. To increase the contrast between the sign and the background a white background panel is recommended as shown in Figure 41.

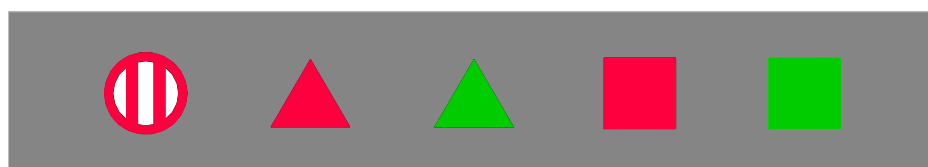

Figure 40 *Daymarks defined by IALA Recommendation O-113*

From visual perception a white background panel does not increase the daymark range but makes the signs more conspicuous.

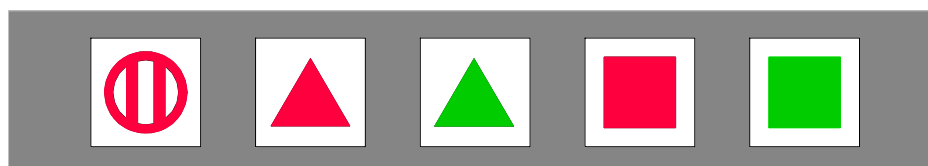

Figure 41 *Preferred daymark design*

8.2.6. DESIGN OF SIGNS

The aspect of the limited eye resolution should be taken into account when designing a sign.

EXAMPLE 1

The IALA recommendation O-113 on the marking of bridges recommends a circle with white and red vertical stripes. It does not define the exact picture of the daymark and the number of stripes, so both signs shown in Figure 42 are valid.

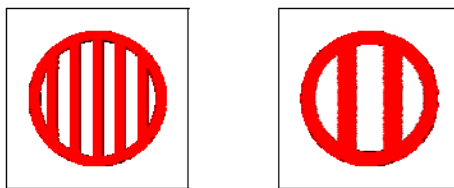

Figure 42 Sign: best point of passage

However, the eye resolution for the sign on the left shows very small stripes so the daymark range will be significantly shorter than for the right one. It is recommended to use the design in the right picture.

EXAMPLE 2

A direction arrow is used at a channel division, when one channel is closed, to show the mandatory direction. Figure 43 shows two designs of a direction arrow. The arrowhead of the left design is very small and will become invisible from a short viewing distance. The information (direction) is lost because the observer will see a black horizontal bar at far distance.

The design in the right picture has an arrowhead, which is more than two times larger. This will increase the daymark range by a factor more than two, so this design is preferred.

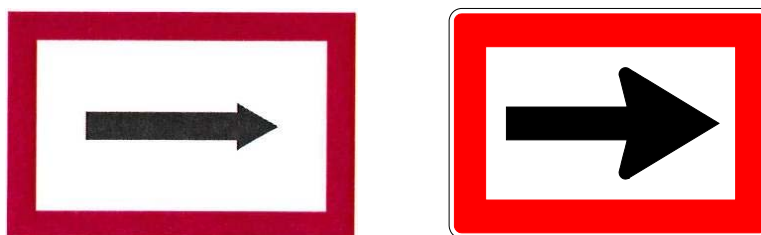

Figure 43 Direction arrow, showing preferred design in the right hand picture

A third example provided by the Canadian Coast Guard is given in ANNEX E.

8.3. GENERAL DESIGN METHODOLOGY

When designing a daymark, the visual aspects should be regarded first, because the visual aspect is directly linked to the mariners need.

The following procedure shows some steps to find an appropriate design for the required daymark. The procedure may be changed due to the knowledge of the authorities and local conditions.

In many cases it is not suitable to design each daymark separately. It is more effective to create classes of daymarks with the intent to cover all applications of a region.

The result of the procedure may vary depending on the choice of convention adopted by the Competent Authority.

The procedure starts with the collection of the parameters to use as input.

The design (size, profile, colour) can then be derived in several steps.

8.3.1. INPUT

- the type of daymark (MBS, buoy, fixed, ...);
- purpose and required range;
- for fixed AtoN: arc (horizontal sector of utilisation: Omnidirectional / unidirectional);
- background: shore (albedo), sky, water surface, snow, ice.

8.3.2. STEP 1

- position and Height above sea level (see section 6.1);

Note: For some daymarks the position cannot be changed.

8.3.3. STEP 2

- minimum dimension for the different shapes (Buoy size, top mark, boards);

Note: A convention about the required viewing angle should be in accordance with section 8.1.3

8.3.4. STEP 3

- choose a profile according to Section 5.1: Flat, rotational symmetry (solid), crossed plates, lattice construction;
- is a Topmark required?

8.3.5. STEP 4

- choose a colour according to existing recommendations, guidelines and standards:
 - MBS;
 - E-112 leading lines, dayboards;
 - E-108 ordinary colour, fluorescent colour, combination of colours.
- establish the required contrast and size of the coloured stripes of a two coloured daymark;
- establish the required contrast of a daymark to the background.

8.3.6. STEP 5

- consider further design aspects, for example:
 - hydrostatic design of buoys;
 - safe access for maintenance;
 - cost;
 - supporting structure;
 - wind load;
 - wave force.
- consider previous experience.

As a result of step 5 it might be established that the design of the daymark is cost prohibitive or is not viable taking into account wind load, wave force or similar aspects. In these situations, the input parameters should be checked and changed. With the new input the steps should be repeated. In general, if the required range cannot be achieved it is possible to use smaller daymarks at shorter interval distances.

8.4. LIMITATIONS AND SERVICE FACTORS

8.4.1. SUPPORTING STRUCTURE

The tools to optimise the visual properties of a daymark are mainly limited to size and contrast. To provide a long range often means to build large daymarks. However, the size cannot be increased due to the following limitation:

- weight;
- wind force;
- snow and ice accumulation.

All three aspects cause the fixed or floating supporting structure to become very large and costly. For this reason, there is a need to find an acceptable balance between the visual features of a daymark and the practical installation.

8.4.2. COLOUR FADING

Fading of the daymark's colour is a result of the attack by the sunlight in combination with humidity, acid rain and mechanical abrasion. Selection of the type of paint system, coloured film or plastic material should be made for maximum stability. Service providers should carry out periodic tests to confirm that the daymark colour remains within IALA guidance. It may be necessary to increase the frequency of painting in order to ensure that the daymark colour maintains its performance within IALA guidance.

8.4.3. BIRD FOULING

Bird fouling can obscure the colour of a daymark and prevent identification. The corrosive effects of bird fouling can cause damage leading to reduced life or premature failure. Daymark design must therefore be such as to avoid providing any natural bird resting sites. The use of long flexible spikes on all potential land sites can be helpful. However, care must be taken to ensure that these do not create a hazard for people attending the AtoN. (See [21])

8.4.4. ENVIRONMENTAL CONSIDERATIONS IN BUOY DESIGN

Local environmental conditions can give rise to the need for special design of daymarks that may not conform to the general guidance in this document. Such conditions include drifting ice, debris in rivers and buoys in breaking wave conditions.

Buoys located in areas exposed to annual drifting ice, possibly of considerable thickness, that can destroy equipment mounted on the buoy body. Buoys in such areas must generally be designed with a slender body with minimal projections and be completely sealed. Use of additional daymark boards or topmark may not be feasible. Consequently, the use of shape recognition for lateral buoys is not always possible.

8.5. DESIGN EXAMPLES

8.5.1. EXAMPLE 1

A pair of lateral buoys with a daymark range of 3 M

Minimum observer's height above sea level: 1 m

Step 1

Position is given by nautical requirements only.

Height (geographical range) can be neglected (see section 6.1).

Step 2

Size of the buoy for a convention 3' vertical and 1' horizontal;

- Daymark height, $H = 3 \times 1852\text{m} \times \tan(3') \approx 4.9\text{ m}$;
- Daymark width, $W = 3 \times 1852\text{m} \times \tan(1') \approx 1.6\text{ m}$;
- The daymark size of the buoy is set to a height of 4.9 m and a diameter of 1.6 m.

Step 3

Preferred 3D profile: Solid shape with rotational symmetry (see section 5.1.2).

To increase the width and to provide shape recognition additional wings should be used.

Shape recognition of wings is acceptable, no topmark required.

Step 4

- Ordinary Red or Green;
- Coloured plastic (non-fluorescent).

Step 5

- Manufacturing: roto-moulding polyethylene;
- Confirm the acceptability of dimensions with other tools (e.g. hydrostatic or wind load calculation);
- Optional: solar box with a light on top of the buoy.

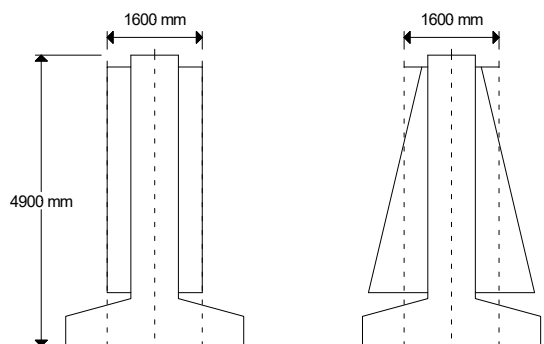

Figure 44 *Resulting buoy shape for Example 1*

8.5.2. EXAMPLE 2

A pair of lateral buoys with a daymark range of 1 NM

Minimum observer's height above sea level: 1 m

Step 1

Position is given by nautical requirements only.

Height (geographical range) can be neglected (see section 6.1).

Step 2

Size of the buoy for a convention 3' vertical and 1' horizontal;

- Daymark height, $H = 1 \times 1852\text{m} \times \tan(3') \approx 1.6\text{ m}$;
- Daymark width, $W = 1 \times 1852\text{m} \times \tan(1') \approx 0.54\text{ m}$;
- The daymark size of the buoy is set to a height of 1.6 m and a diameter of 0.54 m;
- For the conical shape the required width is the average diameter of the cone.

Step 3

Preferred 3-D profile: solid shape with rotational symmetry (see section 5.1.2).

To improve recognition, the buoy should be designed with conical and cylindrical shapes according to IALA MBS.

Step 4

- Ordinary Red or Green;
- Coloured plastic (non-fluorescent).

Step 5

- Manufacturing: rotomoulding polyethylene;
- Confirm the acceptability of dimensions with other tools (e.g. hydrostatic or wind load calculation).

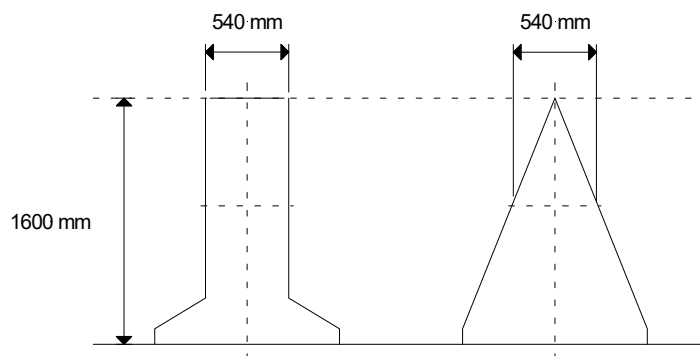

Figure 45 Resulting buoy shape for Example 2

8.5.3. EXAMPLE 3

Lateral daymarks for **port entrance, fixed**, with a daymark range of **5 NM**

Minimum observer's height above sea level: 1 m

Step 1

Fixed Position is given by nautical requirements only (geographical co-ordinate)

Height (geographical range) can be derived from section 6.1

$$R_g = 2.03(\sqrt{h_o} + \sqrt{h_{b,min}}) \rightarrow h_{b,min} = \left(\frac{R_g}{2.03} - \sqrt{h_o}\right)^2 = 2.1m$$

Equation 7 Deriving geographical range from height

Where:

R_g is the geographic range (nautical miles)

h_o is the elevation of the observer's eye (metres)

$h_{b,min}$ lowest part of the daymark above sea level (see Equation 1)

Step 2

Size of the daymark for a convention 3' vertical and 1' horizontal.

- Daymark height $H = 5 \times 1852m \times \tan(3') \approx 8.1$ m;
- Daymark width $W = 5 \times 1852m \times \tan(1') \approx 2.7$ m.

The daymark should be visible from a sector of approximately 180° outside the port.

Step 3

In this step it is decided to provide colour recognition only. Shape recognition can be omitted. No topmark is required.

A cylindrical structure with min. 10.2 m (8.1 m + 2.1m) above sea level and a diameter of min. 2.7 m is chosen.

Step 4

Ordinary Red or Green, painted on structure.

To increase conspicuity the lower part of the building is painted white.

(8.1 m) be painted in red or green and the lowest part (2.1m) of the building will be painted in white.

Step 5

Confirm the acceptability of dimensions with other tools (e.g. wind load calculations)

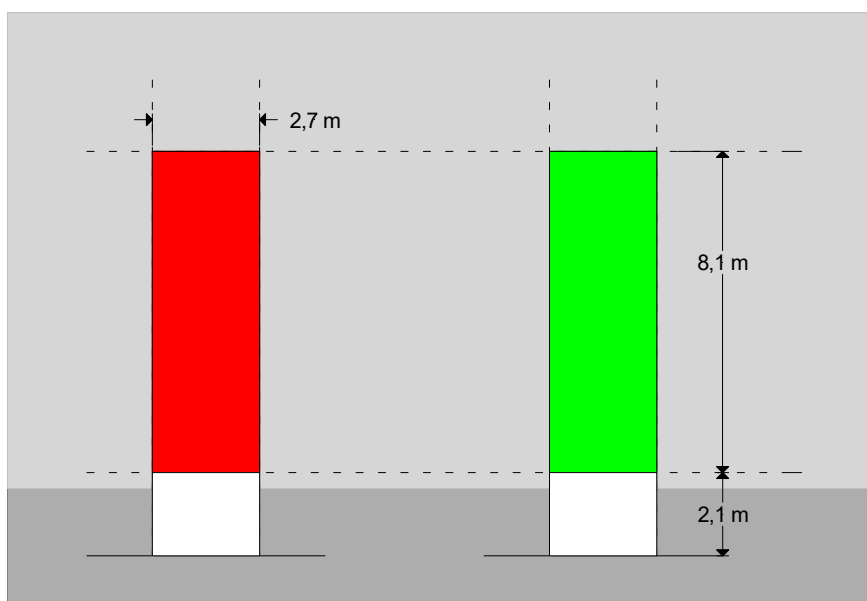

Figure 46 Resulting daymark shape for Example 3

8.5.4. EXAMPLE 4

South cardinal buoy with a day mark range of 1.5 NM equipped with solar panels and top marks

Step 1

Position is given by nautical requirements only.

Height (geographical range) can be neglected (see section 6.1).

Step 2

Size of each stripe for a convention 3' vertical and 1' horizontal (see section 5.5)

- Daymark height, $H = 1.5 \times 1852\text{m} \times \tan(3') \approx 2.4 \text{ m}$;
- Daymark width, $W = 1.5 \times 1852\text{m} \times \tan(1') \approx 1.2 \text{ m}$.

The daymark size of each coloured stripe is set to a height of 2.4 m and a diameter of 1.2 m.

Step 3

From design criteria a structure with additional wings is used to increase the width of the daymark and therefore improve recognition.

The hull of the buoy is set to 3 metres by the designer.

The dimension X of the topmark becomes 25% of the diameter of the hull. The proportions of the topmark are calculated according to section 8.1.8.2.

Step 4

- Ordinary Yellow and black;
- Coloured plastic (non-fluorescent).

Step 5

- Manufacturing: 3 m diameter elastomeric hull;
- The total height of the day mark is 4.8 meters (two horizontal stripes 2 x 2.4 m);
- Confirm the acceptability of dimensions with other tools (e.g. hydrostatic or wind load calculation);
- Solar panels are placed in the lower black part of the buoy.

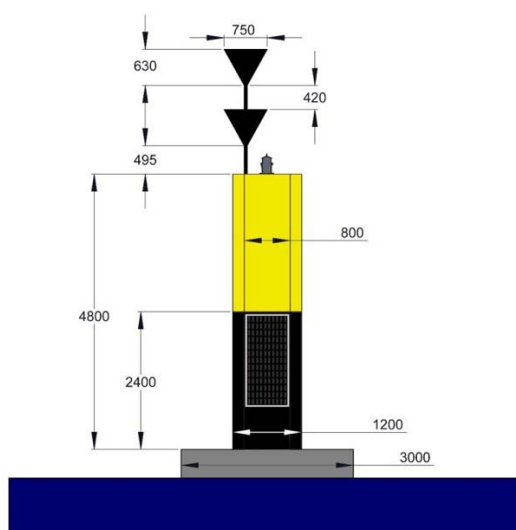

Figure 47 Resulting design for Example 4 (units are in mm)

8.5.5. EXAMPLE 5

A set of lateral daymarks with a range of 4M and a limited arc of utilisation on a small supporting structure

Step 1

Position is given by nautical requirements only.

Height (geographical range) can be neglected (see section 6.1).

The arc of utilisation is less than 60°

Step 2

The daymark should have shape recognition with cone (triangle) and cylinder (rectangle). The size of the shapes is calculated for a convention of 3' with the Geometry of topmarks. (see section 8.1.8.2)

- Daymark width, $W = X = 4 \times 1852\text{m} \times \tan(3') \approx 6.5 \text{ m}$;
- For green triangle: $H_{\text{green}} = 0.9 \times 6.5\text{m} \approx 5.8 \text{ m}$;
- For red rectangle: $H_{\text{red}} = 1.25 \times 6.5\text{m} \approx 8.1 \text{ m}$.

Step 3

Because of the limited arc of utilisation, a flat daymark is chosen

Step 4

Ordinary Red and Green Colour on a steel construction

Step 5

As a result of design consideration about stability, wind load and cost, it is decided to use a lattice construction on a thin steel supporting structure.

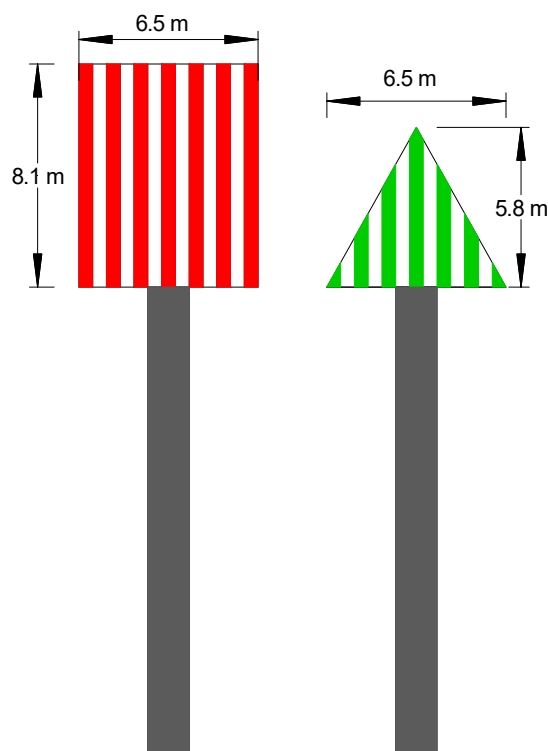

Figure 48 *Resultant design of Example 5*

9. ACRONYMS AND ABBREVIATIONS

AtoN	Aid(s) to Navigation
CEVNI	Code Européen des Voies de Navigation Intérieure
CIE	Commission Internationale de l'Eclairage (International Commission on Illumination)
DR	Daymark Range
IALA	International Association of Marine Aids to Navigation and Lighthouse Authorities
MBS	IALA Maritime Buoyage System
NCS	Natural Colour System (Sweden)
NM	Nautical Miles
RAL	RAL Classic system (<i>Reichs-Ausschuß für Lieferbedingungen und Gütesicherung</i>)
SIGNI	Signs and Signals on Inland Waterways, UN, ECE, Resolution No 22



SMA	Swedish Maritime Administration
2-D	2-Dimensional
3-D	3-Dimensional

10. REFERENCES

- [1] IALA Maritime Buoyage System and other Aids to Navigation.
- [2] Signalisation maritime Documentation technique, French lighthouse technical documentation: CETMEF
- [3] CIE110 Spatial distribution of daylight - Luminance distribution of various reference skies.
- [4] IALA Conference Presentation 1990 about lettering and signs, 'Studies on the recognizability of symbols and letterings on aids to navigation, Dr. Gerdes, Federal Republic of Germany.
- [5] IALA Guideline 1023 The Design of Leading Lines.
- [6] Theorie der horizontalen Sichtweite, Theory of horizontal visual range, Koschmieder, Meteorologische Zeitschrift 11/1926.
- [7] Farbe und Sichtbarkeit, Colour and visibility Hoffmann, DFVLR, 1977, Germany.
- [8] M. Blaise, IALA Bulletin No. 47 (April, 1971) article Titled 'Daymarks as Aids to Navigation'.
- [9] IALA Recommendation E-200 On Marine Signal Lights.
- [10] IALA NAVGUIDE.
- [11] IALA Maritime Buoyage System.
- [12] IALA Recommendation E-108 on Surface Colour.
- [13] Standardization of U.S. Coast Guard Leading Lines, IALA Conference 1998, Engineering.
- [14] Grundlagen der Lichttechnik, Fundamentals of light technology: Dietrich Gall, Germany.
- [15] Wikipedia article 'Albedo', 2011-08-16
- [16] Libro de Normas Técnicas of 1986. Ministerio de Obras Públicas y Urbanismo. Spain
- [17] Manual de Sinalização Náutica of the Brazilian lighthouse service.
- [18] 'Über den Einfluss der Komponenten des Wasserverkehrssystem auf die Sicherheit des Seeschiffsverkehrs', University of Hanover, Germany.
- [19] IALA Recommendation on the Marking of Fixed Bridges and Other Structures over Navigable Waters.
- [20] Basic Guidelines for the design of visual marine aid to navigation daymarks, Puertos del Estado, Spain, 2010
- [21] IALA Guideline 1091 on Bird Deterrents.

ANNEX A PHYSICAL MODEL OF KOSCHMIEDER'S LAW

In the physical model of Koschmieder, the visible luminance of the object at the Observer's eye can be calculated as well:

$$L_o(d) = L_o * e^{-z*d} + L_b * (1 - e^{-z*d})$$

Equation 8 Visible luminance

Where:

L_o is the luminance of the object

L_b is the luminance of the background

z is the exponential factor (total attenuation includes absorption and scattering)

d is the distance

The main conclusion of Koschmieder's law is that an object seen from a far distance will fade and contrast becomes zero.

The original formula of Koschmieder does not include colour. This was added by Hoffmann in 1977 [7]. He calculated the movement of chromaticity X, Y, Z depending on the distance, where Y is identical with L.

$$X_o(d) = X_o * e^{-z*d} + X_b * (1 - e^{-z*d})$$

$$Y_o(d) = Y_o * e^{-z*d} + Y_b * (1 - e^{-z*d})$$

$$Z_o(d) = Z_o * e^{-z*d} + Z_b * (1 - e^{-z*d})$$

Equation 9 Movement of chromaticity

With these calculations it can be shown that the colour of the object will move to the colour of the background when seen from afar.

Although the formulae above include colour it does not include the spectral dependency of the atmospheric light scattering. This could be done with the spectral distribution of the light radiance S_λ .

$$S_{\lambda,o}(d) = L_{\lambda,o} * e^{-z_\lambda*d} + Z_{\lambda,b} * (1 - e^{-z_\lambda*d})$$

Equation 10 Spectral dependency of atmospheric light scattering

This calculation requires the spectral distribution of the background $S_{\lambda,b}$, the object $S_{\lambda,o}$ and the exponential factor z_λ .

ANNEX B STATISTICAL DISTRIBUTION OF SKY LUMINANCE

As an example, the statistical distribution of the sky luminance near the horizon is shown in Figure 49. The values are based on measurements of the German administration at the Baltic Sea from January to December 2003.

Luminance of the sky near horizon

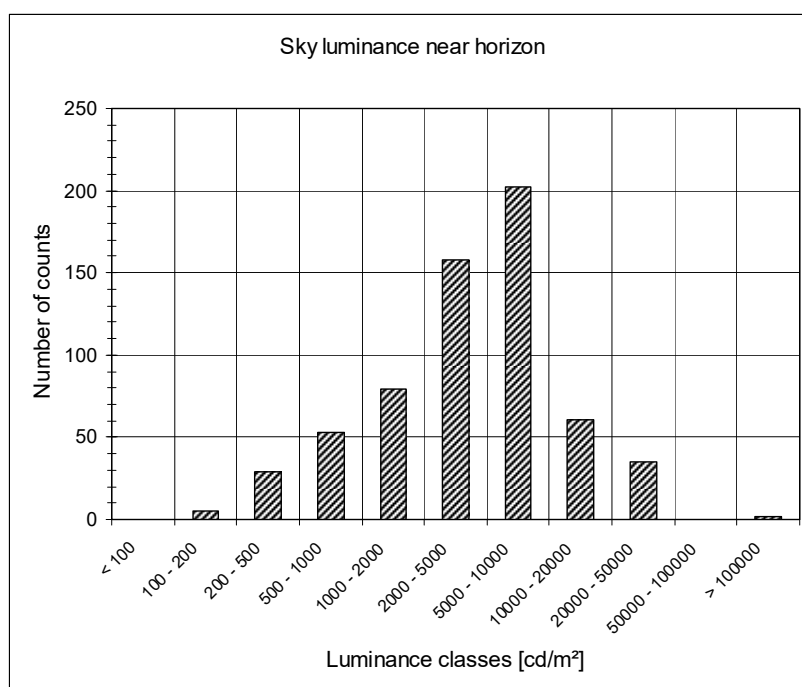

Figure 49 *Statistical distribution of sky luminance, Baltic Sea 2003*

Luminance of the water surface near horizon

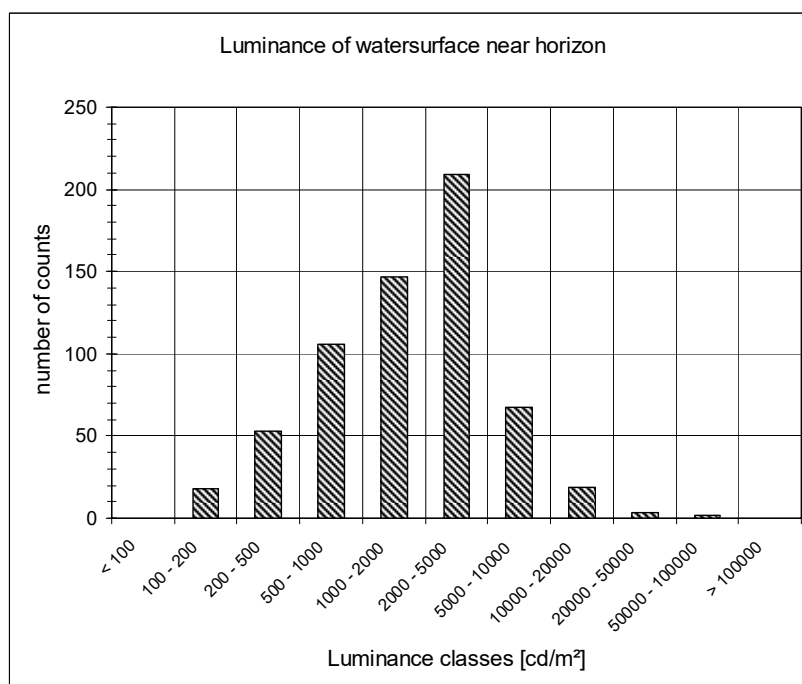

Figure 50 *Statistical distribution of water surface luminance, Baltic Sea 2003*

ANNEX C SIMPLE MODEL OF THE HUMAN EYE

C 1 **GENERAL INFORMATION**

Both physical and psychological aspects of the observer have influence on the visual perception. Although the human eye acts as the physical sensor, the picture the observer sees is the result of an image processing by the neuronal parts of the eye and the brain.

A simplified model of the human eye is shown in Figure 51.

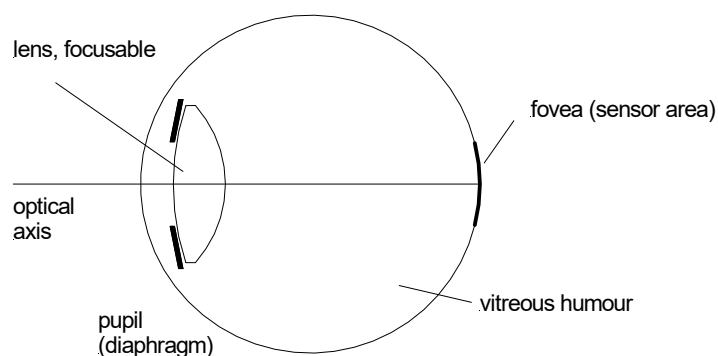

Figure 51 *Simple model of the eye*

The simple optical model of the human eye consists of a focusable lens, a pupil, which defines the open diameter of the lens and the fovea (sensor) near the optical axis.

The eye has the following properties:

- focal length: approximately 16 mm when focused at infinity;
- pupil diameter: 2 - 8 mm;
- sensor density at fovea: cones 142 000 cells/mm² (≈ 377 cells/mm);
- visual sensitivity: approx. 10⁻⁵ cd/m² - 10⁺⁵ cd/m².

The eye has two different sensor types: cones and rods. The cones are for daytime and the rods are for night-time perception. For daymarks the cones are relevant. It can be assumed that the identification of a daymark requires that the observer looks straight at it. That means the daymark and its picture are at the optical axis of the eye. In this region the cone density is at its maximum, so the eye resolution has its maximum too.

The fovea cones have a distance of about 1/ 377 mm ≈ 2.65 μm and this distance corresponds to an angular separation of:

$$\alpha = \arctan\left(\frac{2.65\mu\text{m}}{16\text{mm}}\right) \approx 0.57'$$

Equation 11 *Angular separation of Fovea cones*

As shown above the theoretical eye resolution can be less than 1'. However, it is an accepted convention to use 1' (arc minute) as an approximation for the eye resolution. Eye resolution means that two small objects with good contrast can be seen as two different objects when the viewing angle is at least 1'.

C 2 SHAPE RECOGNITION

A picture of the object (daymark) is projected at the fovea. In a simple model the sensors at the fovea (cones) have a distance of approx. $2.65 \mu\text{m}$ which leads to a resolution of $0.57' = 0.166 \text{ mrad}$ (Figure 52).

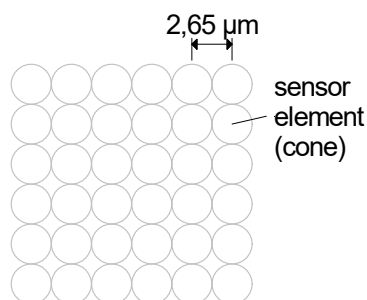

Figure 52 *Simple fovea model*

When the observer sees a simple daymark shape (cylinder, cone, sphere) the sensor elements are stimulated as shown in Figure 52.

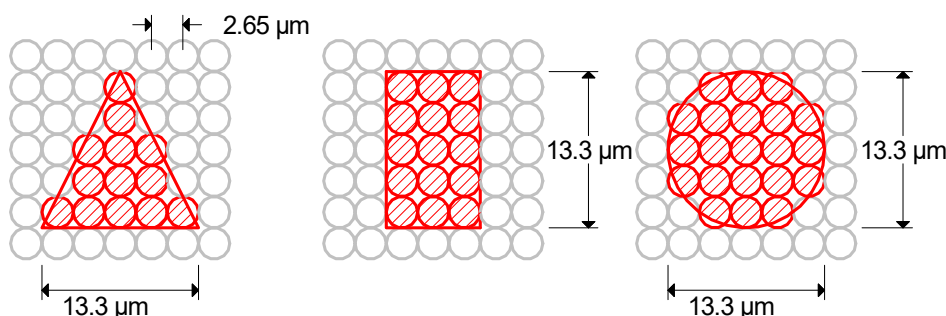

Figure 53 *Stimulated cones for simple shapes*

Figure 53 illustrates the influence of the sensor density at fovea on shape recognition. The three simple IALA shapes can be safely identified when the shape is projected into an array of 5×5 sensor elements.

So the minimum outer dimension of a simple shape projected at the fovea should have approx. $13.3 \mu\text{m}$. Combined with the focal length of the eye (approx. 16 mm) the minimum value for shape identification is:

$$\alpha_{shape} = \arctan\left(\frac{1.33\mu\text{m}}{16\text{mm}}\right) = 0.0476^\circ \approx 2.86' \approx 3'$$

Equation 12 *Minimum value for shape identification*

ANNEX D BLAISE THEORY¹

M. P. Blaise, from the French administration, published a theory in IALA bulletin April 1971. He stated that there are two different regions for visibility.

Angular subtense angle larger than 3' (0.8725 mrad): The visibility depends on the contrast only.

Angular subtense angle smaller than 3' (0.8725 mrad): The visibility depends on the product of the contrast and the apparent solid angle of the object.

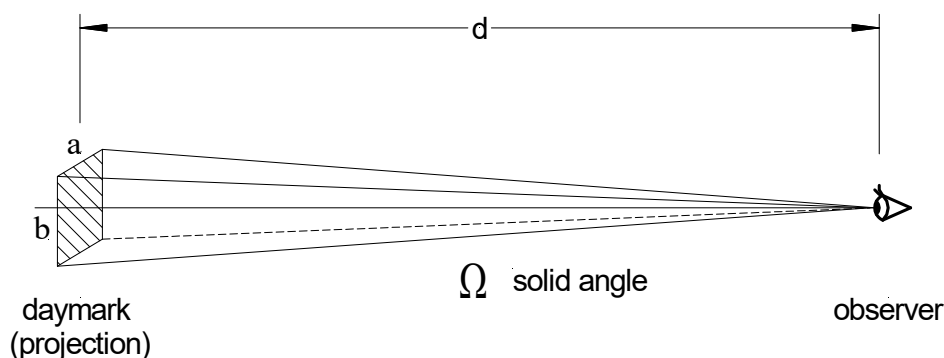

Figure 54 *Blaise theory*

For a large distance d the solid angle is approximated by:

$$\Omega \approx \frac{a * b}{d^2}$$

Equation 13 Solid angle for a large distance

To simplify calculation Blaise assumed $a \approx b$ so the solid angle is $\Omega \approx \frac{a^2}{d^2}$.

The viewing angle of the object is: $\alpha = \frac{a}{d}$ (in radians).

So Blaise theory can be expressed in the following way:

for $\alpha < 0.8725 \text{ mrad}$ required contrast at the observer's eye $|C| > 0.038 * 10^{-6} * \left(\frac{d^2}{a*b}\right)$.

Equation 14 Blaise theory ($\alpha < 0.8725 \text{ mrad}$)

for $\alpha > 0.8725 \text{ mrad}$ required contrast at the observer's eye $|C| > 0.05$.

Equation 15 Blaise theory ($\alpha > 0.8725 \text{ mrad}$)

Remarks:

- 1 Blaise theory is based on simple detection of the daymark not on recognition or identification;
- 2 In the publication, Blaise sets the limit for α to 1 mrad. However, the formula for C is continuous only for $\alpha = 0.8725 \text{ mrad} = 3'$, so this value is chosen here.

ANNEX E EXAMPLE CANADIAN DAYMARKS

The Canadian Coast Guard uses flat day marks on fixed aids to navigation. These flat day marks are defined in an operational directive. For the lateral marks the following daymarks are specified.

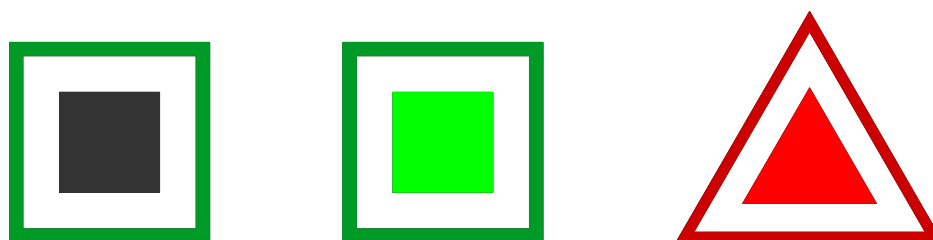

Figure 55 Canadian standard daybeacon

The shapes of the daymarks are in accordance with the IALA MBS. The colour in the centre is fluorescent red or green. For the port hand day beacon a black square may be used as an alternative.

The signs have a white contrast panel, which is surrounded by a small tape of retroreflective material in red or green.

The Canadian directive gives information about the useful range (design distance) for a specific size of the central shape.

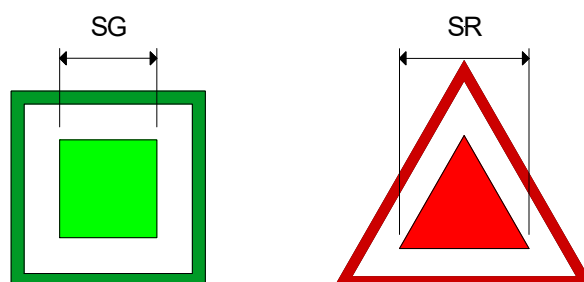

Figure 56 Relevant dimensions of the daymark

Table 9 Design distance for Canadian daybeacons

Type	Dimension	Design distance	Viewing angle at design distance
Port	SG = 0.3 m	1000 m	1'
	SG = 0.45 m	1500 m	1'
	SG = 0.9 m	3000 m	1'
Starboard	SR = 0.4 m	1000 m	1.4'
	SR = 0.6 m	1500 m	1.4'
	SR = 1.2 m	3000 m	1.4'

From the table above it can be derived that there will not be shape recognition of the central shape at design distance, because the viewing angle is near the eye resolution (see 7.1). If the dayboard size were chosen to provide a viewing angle of 3', they should be 3 times larger than described. This would cause very high costs especially for the supporting structures and the measures taken against the wind force.



However, the Canadian directive is a very good example of how to handle this handicap.

The recognition is improved by using:

- a white contrast panel;
- fluorescent colour;
- black instead of green for port sign.

Therefore, at large observation distances the mariner will identify the beacon by colour and not by shape.

Because green cannot be identified as well as red from a long distance, the use of a black square instead may be more effective.